



Bio Plas, Inc.

2023 Product Catalog



www.bioplas.com



Bio Plas, Inc.

Premium Laboratory Disposables. Made In The USA Since 1977

A Woman Owned Small Business

Uni-Flex™ Safety Caps

Hexa-Flex™ Safety Caps

Screw Cap Microcentrifuge Tubes

Sterile Cryogenic Tubes

G-Tube™ Flat Top Microcentrifuge Tubes

Sterile G-Tube™ Flat Top Microcentrifuge Tubes

Siliconized G-Tube™ Flat Top Microcentrifuge Tubes

Snap Cap Microcentrifuge Tubes

5mL Flat Top Microcentrifuge Tubes **NEW**

15mL & 50mL Centrifuge Tubes **NEW**

Pestles (In Tubes)

Micro Tube Tool

64 & 96 Well Micro Tube Racks

80 Well Micro Tube Racks

Polyester Foam Test Tube & Microcentrifuge Tube Racks

Consumables For Thermal Cycling (PCR Tubes)

BioFlex Flat Top PCR Tubes **NEW**

Astral™ Inoculation System

Bacti Cell Spreaders

Histo Plas Capsettes™ & Uni-Capsettes™

Bio Plas, Inc.

4380 Redwood Hwy, Suite C-16, San Rafael, CA 94903

Tel; (415) 472-3777 Fax: (415) 472-3758

info@bioplas.com www.bioplas.com



Uni-Flex™ Safety Caps

A safe, economical, way to cap and recap blood collection tubes and disposable glass culture tubes regardless of manufacturer. **Uni-Flex® Safety Caps** are available for a wide range of biomedical and industrial applications.

The **Uni-Flex® Safety Cap's** liquid tight seal ensures sample integrity and prevents spillage of serum samples.

Uni-Flex® Safety Caps protect your laboratory staff from the aerosols of highly infectious organisms such as TB and the HTLV-III virus.

Uni-Flex® Safety Caps Features:

- Will not aerosol when opened
- 10, 12, 13 and 16mm sizes fit all varieties of blood collecting and disposable culture tubes
- Liquid tight seal prevents sample evaporation. **The Uni-Flex® Safety Cap** is designed to hold under centrifugation, agitation, refrigeration and freezing.
- Easy identification of samples: **Uni-Flex® Safety Caps** are available in seven colors that conveniently correspond to blood collection cap colors
- **The Uni-Flex Safety Cap** locks securely onto the outside of the tube lip to prevent evaporation.
- Easy, one hand removal and application. To close, press down firmly with thumb to lock in place. To open, simply pry cap up with thumb.
- Easy to label: Write directly on the cap with indelible ink
- Clear, natural colored caps are trace-metal free
- Made In The USA!



Three Internal Seal Rings





Uni-Flex™ Safety Caps

"The Premium Tube Cap With The Triple-Lipped Internal Seal!"

Uni-Flex™ Safety Cap Ordering Information				
Catalog #	Description	Color	Pkg. Qty.	Pkgs./ Case
6500	Uni-Flex® Safety Caps for 10mm Blood Collecting & Culture Tubes	White	1,000	10
6505	Uni-Flex® Safety Caps for 10mm Blood Collecting & Culture Tubes	Red	1,000	10
6510	Uni-Flex® Safety Caps for 10mm Blood Collecting & Culture Tubes	Lavender	1,000	10
6515	Uni-Flex® Safety Caps for 10mm Blood Collecting & Culture Tubes	Green	1,000	10
6520	Uni-Flex® Safety Caps for 10mm Blood Collecting & Culture Tubes	Blue	1,000	10
6525	Uni-Flex® Safety Caps for 10mm Blood Collecting & Culture Tubes	Grey	1,000	10
6530	Uni-Flex® Safety Caps for 10mm Blood Collecting & Culture Tubes	Yellow	1,000	10
6550	Uni-Flex® Safety Caps for 12mm Culture Tubes & 13mm Blood Collecting Tubes	White	1,000	10
6555	Uni-Flex® Safety Caps for 12mm Culture Tubes & 13mm Blood Collecting Tubes	Red	1,000	10
6560	Uni-Flex® Safety Caps for 12mm Culture Tubes & 13mm Blood Collecting Tubes	Lavender	1,000	10
6565	Uni-Flex® Safety Caps for 12mm Culture Tubes & 13mm Blood Collecting Tubes	Green	1,000	10
6570	Uni-Flex® Safety Caps for 12mm Culture Tubes & 13mm Blood Collecting Tubes	Blue	1,000	10
6575	Uni-Flex® Safety Caps for 12mm Culture Tubes & 13mm Blood Collecting Tubes	Grey	1,000	10
6580	Uni-Flex® Safety Caps for 12mm Culture Tubes & 13mm Blood Collecting Tubes	Yellow	1,000	10
6600	Uni-Flex® Safety Caps for 13mm Culture Tubes	White	1,000	10
6605	Uni-Flex® Safety Caps for 13mm Culture Tubes	Red	1,000	10
6610	Uni-Flex® Safety Caps for 13mm Culture Tubes	Lavender	1,000	10
6615	Uni-Flex® Safety Caps for 13mm Culture Tubes	Green	1,000	10
6620	Uni-Flex® Safety Caps for 13mm Culture Tubes	Blue	1,000	10
6625	Uni-Flex® Safety Caps for 13mm Culture Tubes	Grey	1,000	10
6630	Uni-Flex® Safety Caps for 13mm Culture Tubes	Yellow	1,000	10
6700	Uni-Flex® Safety Caps for 16mm Blood Collecting & Culture Tubes	White	1,000	10
6705	Uni-Flex® Safety Caps for 16mm Blood Collecting & Culture Tubes	Red	1,000	10
6710	Uni-Flex® Safety Caps for 16mm Blood Collecting & Culture Tubes	Lavender	1,000	10
6715	Uni-Flex® Safety Caps for 16mm Blood Collecting & Culture Tubes	Green	1,000	10
6720	Uni-Flex® Safety Caps for 16mm Blood Collecting & Culture Tubes	Blue	1,000	10
6725	Uni-Flex® Safety Caps for 16mm Blood Collecting & Culture Tubes	Grey	1,000	10
6730	Uni-Flex® Safety Caps for 16mm Blood Collecting & Culture Tubes	Yellow	1,000	10

Made In The USA!



Bio Plas, Inc. A Woman Owned Small Business
www.bioplas.com info@bioplas.com



Hexa-Flex™ Safety Caps

The Premium Multiple-Fit Tube Cap

A safe, economical, way to cap and recap blood collection tubes and disposable glass culture tubes regardless of manufacturer. **Hexa-Flex™ Safety Caps** are available for a wide range of biomedical and industrial applications and fit six different sized tubes. **Hexa-Flex™ Safety Caps** come in a variety of colors for coding samples.

The **Hexa-Flex™ Safety Cap's** liquid-tight seal ensures sample integrity and prevents spillage of serum samples. **Hexa-Flex™ Safety Caps** are available in a variety of colors which helps guard against sample cross-contamination and are convenient for color-coding to particular R&D projects. **Hexa-Flex™ Safety Caps** protect your laboratory staff from the aerosols of highly-infectious organisms such as TB and the HTLV-III virus.

Hexa-Flex™ Safety Caps:

- Fit a variety of tubes, including 10,12, 13, 16 and 18mm sizes of blood collecting and disposable culture tubes.
- Liquid-tight seal prevents sample evaporation. The **Hexa-Flex™ Safety Cap** is designed to hold under centrifugation, agitation, refrigeration and freezing.
- Easy identification of samples. **Hexa-Flex™ Safety Caps** are available in seven colors that conveniently correspond to blood collection cap colors.
- Lock securely onto, or into, the tube lip to prevent evaporation.
- Easy, one-hand removal and application. To close, press down firmly with thumb to lock in place. To open, simply pry cap up.
- Clear, natural colored caps are trace-metal free.

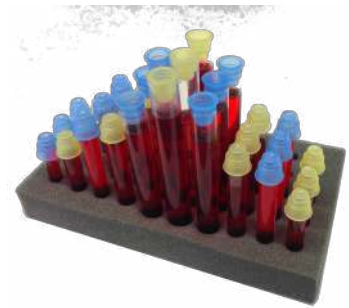

Made In The USA!



Hexa-Flex™ Safety Cap Ordering Information

Cat #	Description	Color	Pack Qty	Packs/ Case
8350	For 10mm, 12mm, 13mm, and 16mm and 18mm Blood Collection and Culture Tubes	Natural	500	10
8355	For 10mm, 12mm, 13mm, and 16mm and 18mm Blood Collection and Culture Tubes	Red	500	10
8360	For 10mm, 12mm, 13mm, and 16mm and 18mm Blood Collection and Culture Tubes	Lavender	500	10
8365	For 10mm, 12mm, 13mm, and 16mm and 18mm Blood Collection and Culture Tubes	Green	500	10
8370	For 10mm, 12mm, 13mm, and 16mm and 18mm Blood Collection and Culture Tubes	Blue	500	10
8375	For 10mm, 12mm, 13mm, and 16mm and 18mm Blood Collection and Culture Tubes	Grey	500	10
8380	For 10mm, 12mm, 13mm, and 16mm and 18mm Blood Collection and Culture Tubes	Yellow	500	10





Screw-Cap Microcentrifuge Tubes

Bio Plas Screw-Cap Microcentrifuge Tubes are ideal for any sample-processing or storage application and for working with valuable or hazardous cells and materials.

The extraordinary strength, safety and reliability of the **Bio Plas Screw-Cap Microcentrifuge Tubes** let you perform procedures that simply can't be done with many other tubes. Spin them, store them, transport them (even by air). Boil, irradiate, or immerse them in the vapor phase of liquid nitrogen. They'll stand up to the test!

Inside the Screw Cap, our ethylene propylene O-Ring forms a secure and leak-proof seal. The **Bio Plas Screw-Cap Microcentrifuge Tube's** square threads won't strip and they are on the outside of the tube, so you minimize the risk of contaminating your sample or letting it contaminate the Lab Tech.

Screw Cap Microcentrifuge Tube Features:

- **Sample Integrity:** O-rings create a positive seal to prevent leaking during processing, storage, or transport. Tubes made of inert virgin-polypropylene copolymer, to minimize risk of altering samples.
- **Universal Use:** Accommodates all fixed angle head microcentrifuges (0.5ml and 2.0ml upright models require adapter Cat. No. 4212). Will withstand maximum G-forces up to 20000 x g.
- **Safe and Reliable:** External threads minimize contamination, material hang-up and loss. Screw cap made of same material as tube.
- **Convenient:** Molded ridges on tubes match serrations on racks (Cat. No. 4214), so tubes may be opened with one hand. Upright models stand without a rack. Seamless, conical design lets you extract all of sample with pipette or syringe. Transparent polymer lets you see your sample clearly.
- **Sturdy and Reusable:** Ideal for freezer storage, boiling, autoclaving and irradiation.
- **Made In The USA!**



Autoclavable at 250°F at 15 psi for 15 minutes



Screw-Cap Microcentrifuge Tubes

Screw Cap Microcentrifuge Tube & Cap Ordering Information

Catalog #	Description	Color	Pack Qty	Packs Per Case
4200	0.5mL Screw Cap Tube, Skirted Base, Ribbed	Clear	500	10
4201	0.5mL Screw Cap Tube, Skirted Base, Ribbed	Amber	500	10
4202	1.5mL Screw Cap Tube, Conical Base, Ribbed	Clear	500	10
4202A	1.5mL Screw Tube, Skirted Base, Ribbed	Amber	500	10
4202G	1.5mL Screw Cap Tube, Conical Base, Graduated, Writing Area	Clear	500	10
4203	2.0mL Screw Cap Tube, Conical Base, Ribbed	Clear	500	10
4204	2.0mL Screw Cap Tube, Skirted Base, Ribbed	Clear	500	10
4204A	2.0mL Screw Cap Tube, Skirted Base, Ribbed	Amber	500	10
4204G	2.0mL Screw Cap Tube, Skirted base, Graduated, Writing Area	Clear	500	10
4215R	Screw-Caps for Microcentrifuge Tubes with O-Ring, Polypropylene	Clear	500	10
4216R	Screw-Caps for Microcentrifuge Tubes with O-Ring, Polypropylene	Blue	500	10
4217R	Screw-Caps for Microcentrifuge Tubes with O-Ring, Polypropylene	Yellow	500	10
4218R	Screw-Caps for Microcentrifuge Tubes with O-Ring, Polypropylene	Red	500	10
4220R	Screw-Caps for Microcentrifuge Tubes with O-Ring, Polypropylene	Green	500	10
4221R	Screw-Caps for Microcentrifuge Tubes with O-Ring, Polypropylene	Orange	500	10
4222R	Screw-Caps for Microcentrifuge Tubes with O-Ring, Polypropylene	Black	500	10
4223R	Screw-Caps for Microcentrifuge Tubes with O-Ring, Polypropylene	Violet	500	10
4224R	Screw-Caps for Microcentrifuge Tubes with O-Ring, Polypropylene	Amber	500	10
4214	40 Place Keyed Rack, Anodized Aluminum	Aluminum	1	1

* Bio Plas Screw Caps are manufactured to fit the Bio Plas Screw Cap Microcentrifuge Tubes.
Bio Plas does not guarantee them to fit on any other manufacturers' tubes. *

Free of detectable DNase, RNase, DNA, PCR inhibitors, and endotoxins

Made In The USA!

Bio Plas, Inc. A Woman Owned Small Business
www.bioplas.com info@bioplas.com



Bio Plas Sterile Cryogenic Tubes

Bio Plas Sterile Cryogenic Tubes have an O-Ring Screw Cap for a positive, leak-proof seal. They're designed for safe storage of cells or biological fluids. The Sterile Cryogenic Tubes are ideal for sperm, serum or blood specimens, microbiological cultures, cell cultures, and hazardous or valuable samples.

The rugged, polypropylene copolymer, and uniform wall construction, will stand up to any current microcentrifuge. Plus, our tubes' external threads prevent leaking even under the pressure changes of air transport. No tube offers more security to your sample!



Cat#4200S

Sterile Cryogenic Tube Features:

- **Sample Integrity:** Sterile. Free of detectable DNase, RNase, DNA, PCR inhibitors, and endotoxins.
- **Screw cap with internal O-ring forms a leak-proof seal during processing and storage.**
- **Safe and Efficient:** External thread eliminates material hang-up and minimizes chance of contaminating you or your sample.
- **Convenient:** Conical design lets you retrieve your entire sample. Upright models stand without a rack.
- **Sturdy:** Virtually unbreakable. Will withstand spin speeds of up to 20,000 x G.
- **Made In The USA!**



Cat#4202S



Clear Cap



Cat#4204S

Cryo Tube Ordering Information

Catalog #	Description	Color	Pack Qty	Packs/Case
4200S	0.5mL Assembled Screw Cap Tube, Skirted Base, Ribbed, Sterile	Clear	500	5
4202S	1.5mL Assembled Screw Cap Tube, Conical Base, Graduated, Writing Area, Sterile	Clear	500	5
4203S	2.0mL Assembled Screw Cap Tube, Conical Base, Graduated, Writing Area, Sterile	Clear	500	5
4204S	2.0mL Assembled Screw Cap Tube, Skirted Base, Ribbed, Sterile	Clear	500	5

BIO PLAS, INC. A WOMAN OWNED SMALL BUSINESS

4380 Redwood Hwy, Suite C-16
San Rafael, CA 94903 USA

Tel: (415) 472-3777 Fax: (415) 472-3758
info@bioplas.com www.bioplas.com



Bio Plas G-Tube™

Premium Flat Top Microcentrifuge Tubes

The G-Tube™ Flat Top Microcentrifuge Tube is virtually transparent and far exceeds the toughness of any microcentrifuge tubes. When the **G-Tube™** Flat Top Microcentrifuge Tube cap is closed there will be an audible "snap" that indicates a secure closure has been formed.

Made of tough, clear, proprietary formulated polypropylene, the 0.6mL, 1.5mL and 2.0mL

The G-Tube™ has the same chemical resistant quality as standard tubes, but they're sturdier and virtually transparent to give a better view. The flat top cap is easy to open and still provides a maximum secure seal.

The G-Tube™ is built for high impact usage and will withstand over 30,000 x g when spun. Thicker walls make this the tube of choice for extreme stress, high spinning speeds, autoclaving, boiling, chemical resistance and freezing. Will withstand temperature ranges of -80°C (-112°F) to 121 °C (250°F).



0.6mL G-Tube® Flat Top Microcentrifuge Tube, Yellow, 4042



1.5mL G-Tube® Flat Top Microcentrifuge Tube, Blue 4031



2.0mL G-Tube® Flat Top Microcentrifuge Tube, Orange, 4056

G-Tube™ Flat Top Microcentrifuge Tube Features:

- Made from high quality medical grade resins
- RNase and DNase free. Human DNA free. Non-Pyrogenic
- Ultra low retention
- Lid Closure: The flat top lid forms an extra-tight seal that will not come open during processing. Yet, it's easy to open with thumb pressure or our handy Micro Tube Tool (Catalog #4000.)
- Bio Plas G-Tubes have a textured writing surface on top of the caps. The 1.5ml and 2.0 mL tubes have an additional textured writing surface on the side of the tubes
- Graduation: The 1.5ml tubes and 2.0ml tubes are graduated every 0.5ml
- Boilproof
- Will withstand speeds up to 30000 X G
- Easy needle access through the piercing port in the exact center of the cap
- Autoclavable at 250°F at 15 psi for 15 minutes.
- Withstand temperature ranges from -80°C to 121°C



Bio Plas G-Tube™

Premium Flat Top Microcentrifuge Tubes



G-Tube™ Ordering Information

0.6 mL Catalog #	1.5 mL Catalog #	2.0 mL Catalog #	Description	Color	Pack Qty	Packs Per Case
4040	4030	4050	G-Tube® Flat Top Microcentrifuge Tube	Natural	500	20
4041	4031	4051	G-Tube® Flat Top Microcentrifuge Tube	Red	500	20
4042	4032	4052	G-Tube® Flat Top Microcentrifuge Tube	Yellow	500	20
4043	4033	4053	G-Tube® Flat Top Microcentrifuge Tube	Blue	500	20
4044	4034	4054	G-Tube® Flat Top Microcentrifuge Tube	Green	500	20
4046	4036	4056	G-Tube® Flat Top Microcentrifuge Tube	Orange	500	20
4047	4037	4057	G-Tube® Flat Top Microcentrifuge Tube	Lavender	500	20
4048	4038	4058	G-Tube® Flat Top Microcentrifuge Tube	Amber	500	20
4049	4039	4059	G-Tube® Flat Top Microcentrifuge Tube	Rainbow	500	20



Made In The USA!





Sterile Bio Plas G-Tube™

Premium Flat Top Microcentrifuge Tubes

0.6mL Sterile G-Tube®
Flat Top Microcentrifuge Tube,
Yellow, 4042S



1.5mL Sterile G-Tube® Flat
Top Microcentrifuge Tube,
Natural, 4030S



2.0mL Sterile G-Tube®
Flat Top Microcentrifuge Tube,
Orange, 4056S



The Sterile G-Tube™ Flat Top Microcentrifuge Tube is virtually transparent and far exceeds the toughness of any microcentrifuge tubes. When the Sterile **G-Tube™** Flat Top Microcentrifuge Tube cap is closed there will be an audible "snap" that indicates a secure closure has been formed.

Made of tough, clear, proprietary formulated polypropylene, the 0.6mL, 1.5mL and 2.0mL

The Sterile G-Tube™ has the same chemical resistant quality as standard tubes, but they're sturdier and virtually transparent to give a better view. The flat top cap is easy to open and still provides a maximum secure seal.

The Sterile G-Tube™ is built for high impact usage and will withstand over 30,000 x g when spun. Thicker walls make this the tube of choice for extreme stress, high spinning speeds, autoclaving, boiling, chemical resistance and freezing. Will withstand temperature ranges of -80°C (-112°F) to 121 °C (250°F).

Sterile G-Tube™ Ordering Information

0.6 mL Catalog #	1.5 mL Catalog #	2.0 mL Catalog #	Description	Color	Pack Qty	Packs Per Case
4040S	4030S	4050S	G-Tube® Sterile Flat Top Microcentrifuge Tube	Natural	500	20
4041S	4031S	4051S	G-Tube® Sterile Flat Top Microcentrifuge Tube	Red	500	20
4042S	4032S	4052S	G-Tube® Sterile Flat Top Microcentrifuge Tube	Yellow	500	20
4043S	4033S	4053S	G-Tube® Sterile Flat Top Microcentrifuge Tube	Blue	500	20
4044S	4034S	4054S	G-Tube® Sterile Flat Top Microcentrifuge Tube	Green	500	20
4046S	4036S	4056S	G-Tube® Sterile Flat Top Microcentrifuge Tube	Orange	500	20
4047S	4037S	4057S	G-Tube® Sterile Flat Top Microcentrifuge Tube	Lavender	500	20
4048S	4038S	4058S	G-Tube® Sterile Flat Top Microcentrifuge Tube	Amber	500	20
4049S	4039S	4059S	G-Tube® Sterile Flat Top Microcentrifuge Tube	Rainbow	500	20



Siliconized G-Tube™

Flat Top Microcentrifuge Tubes

Designed for use in biotechnology laboratories such as preparing samples for thermal cycling or whenever complete sample recovery is important.

The **Siliconized G-Tube™ Flat Top Microcentrifuge Tube** is molded from a siliconized virgin polypropylene that exhibits extremely low surface adhesion providing maximum sample recovery.

Siliconized G-Tube™ Flat Top Microcentrifuge Tube Features:

- No special cap locking devices needed
- Safe sample deposit
- Highest impact tube strength with the smoothest interior surface
- Lid Closure: The flat top lid forms an extra-tight seal that will not come open during processing. Yet, it's easy to open with thumb pressure or our handy Micro Tube Tool (Cat #4000).
- Inscribing Patches: All flat top tubes have a textured writing surface on top of the caps. The 1.5ml and 2.0 mL tubes have an additional textured writing surface on the side of the tubes.
- Graduation: The 1.5ml tube is graduated from 0.1 to 1.5ml. The 2.0ml tube is graduated from 0.1 to 2.0ml.
- Finish: The interior has the smoothest, most highly polished surface of any tube on the market. The walls are non-wettable, preventing liquids from adhering to the sides.
- Needle Access: You can easily insert a needle through the target in the exact center of the lid
- Will withstand over 30000 X g when spun. Will withstand temperature ranges of -80°C to 121°C .

Siliconized G-Tube™ Ordering Information			
Catalog #	Description	Pack Qty	Packs Per Case
4160SL	0.6ml G-Tube Flat Top Microcentrifuge Tube	500	20
4162SLS	0.6ml G-Tube, Natural, Individually Wrapped, Sterile	250	20
4165SL	1.5ml G-Tube Flat Top Microcentrifuge Tube	500	20
4167SLS	1.5ml G-Tube, Natural, Individually Wrapped, Sterile	250	20
4168SL	2.0ml G-Tube Flat Top Microcentrifuge Tube	500	20
4169SLS	2.0ml G-Tube, Natural, Individually Wrapped, Sterile	250	20

***Siliconized Products Are Not Recommended For Autoclaving.
Minimum Order Is One case***

Cat# 4160SL



Cat# 4169SLS



Made In The USA!



Snap-Cap Microcentrifuge Tubes

Bio Plas Snap-Cap Microcentrifuge Tubes give a firm, dependable, seal. Their tough virgin-polypropylene construction withstand the rugged G-forces of high-speed centrifugation. Use them with confidence for specimen collection, mixing, electrophoresis sampling/handling, enzyme assays, radioassays, immunoassays and many other applications.

The **Snap-Cap Microcentrifuge Tube** is available in five sizes, 250µl, 400µl, 500µl, 1.5ml and 1.8ml. All sizes have attached, tight-fitting, Snap-Caps for optimal sealing during sample processing and centrifugation.

Colors: Natural (white) for 250µl, 400µl, and 500µl. The 1.5 ml and 1.8ml sizes are available in five colors for color-coding.

The **Snap-Cap Microcentrifuge Tube's** smooth, conical interior lets you remove your entire sample with ease, and without material hang up. You can even cut it to remove a spun pellet. **Snap-Cap Microcentrifuge Tubes** are autoclavable at 250°F at 15 psi for 15 minutes.



Various sizes of the Snap-Cap Microcentrifuge Tubes

Snap Cap Micro Tube Ordering Information				
Catalog #	Description	Color	Pack Qty	Packs Per Case
4003	Micro-Centrifuge Tube 400µl, Polypropylene	White	1000	10
4004	Micro-Centrifuge Tube 400µl, Polyethylene	White	1000	10
4005	Micro-Centrifuge Tube 500µl, Polypropylene	White	1000	10
4025	Micro-Centrifuge Tube 250µl, Polyethylene	White	1000	10
4150	Micro-Centrifuge Tube 1.5ml, Polypropylene	White	1000	10
4151	Micro-Centrifuge Tube 1.5ml, Polypropylene	Red	1000	10
4152	Micro-Centrifuge Tube 1.5ml, Polypropylene	Yellow	1000	10
4153	Micro-Centrifuge Tube 1.5ml, Polypropylene	Blue	1000	10
4154	Micro-Centrifuge Tube 1.5ml, Polypropylene	Green	1000	10
4155	Micro-Centrifuge Tube 1.8ml, Polypropylene	White	1000	10
4156	Micro-Centrifuge Tube 1.8ml, Polypropylene	Red	1000	10
4157	Micro-Centrifuge Tube 1.8ml, Polypropylene	Yellow	1000	10
4158	Micro-Centrifuge Tube 1.8ml, Polypropylene	Blue	1000	10
4159	Micro-Centrifuge Tube 1.8ml, Polypropylene	Green	1000	10
4000	Micro Tube Tool	Blue	4	25



Bio Plas 5ml Flat Top Tubes

The perfect intermediate volume option between traditional microcentrifuge tubes and 15 mL conical tubes.

Bio Plas 5ml Flat Top Tube Features:

- Suitable for all rotors and racks that hold 15 mL conical tubes—no adapters needed.
- Graduated every 250 μ L for easy volume estimation.
- Rated to 25,000 x G for high-speed centrifugation.
- Flat, frosted, cap and a writing surface on the side of the tube.
- Temperature range: -80°C to 100°C.
- For use in pharmaceutical industry, food industry, and molecular biology.
- Manufactured from high-quality, virgin polypropylene to ensure purity and provide excellent optical clarity.
- Free of detectable RNase, DNase, DNA, PCR Inhibitors. Pyrogen-Free.



Cat# 4400



Cat# 4401



Cat# 4400AS

5ml Flat Top Tube Ordering Information

Catalog #	Description	Color	Pack Qty	Packs/Case
4400	5ml Flat Top Microcentrifuge Tube	Clear	200	
4401	5ml Flat Top Microcentrifuge Tube	Assorted	200	
4400S	5ml Flat Top Microcentrifuge Tube, Sterile, 4 Bags of 50 Per pack	Clear	200	
4400AS	5ml Flat Top Microcentrifuge Tube, Sterile, 4 Bags of 50 Per pack	Amber	200	

Assorted colors include an assortment of 4 colors: blue, green, red, yellow. They come in 4 individually-packed, stand-up, resealable pouches for easy access and clean storage.

BIO PLAS, INC. A WOMAN OWNED SMALL BUSINESS

4380 Redwood Hwy, Suite C-16

San Rafael, CA 94903 USA

Tel: (415) 472-3777 Fax: (415) 472-3758

info@bioplas.com www.bioplas.com



Bio Plas 15ml & 50ml Centrifuge Tubes

Bio Plas 15ml & 50ml Centrifuge Tube Features:

- High-clarity, medical-grade polymer.
- 15ml tubes graduated in 1 mL increments. 50ml tubes graduated in 5ml increments.
- Will withstand up to 17,000 × G.
- Temperature range: -80° to 40°C.
- Sterile and certified free of detectable DNase, RNase, DNA, PCR inhibitors, and endotoxins.



Cat# 4500SR



Cat# 4600S



Cat# 4601

5ml Flat Top Tube Ordering Information

Catalog #	Description	Color	Pack Qty	Packs/Case
4500S	15mL Conical Tube, Bulk, Sterile	Clear	50	10
4500SR	15mL Conical Tube, Racked, Sterile (2 Racks Of 25 Tubes Per Pack)	Clear	50	10
4600S	50mL Conical Tube, Bulk, Sterile	Clear	50	10
4600SR	50mL Conical Tube, Racked, Sterile (1 Racks Of 25 Tubes Per Pack)	Clear	25	20
4601	50mL Self-Standing Conical Tube, Sterile	Clear	50	10

BIO PLAS, INC. A WOMAN OWNED SMALL BUSINESS

4380 Redwood Hwy, Suite C-16

San Rafael, CA 94903 USA

Tel: (415) 472-3777 Fax: (415) 472-3758

info@bioplas.com www.bioplas.com



Bio Plas Pestles

Bio Plas disposable polypropylene Pestles may be used to homogenize cells or re-suspend precipitates such as protein or DNA pellets in buffer solutions.

All the packaging options contain products free of detectable RNase, DNase, DNA and Pyrogens. These pestles and tubes are precision manufactured and quality controlled to firmly match together for maximum performance efficiency.

Pestles are conveniently packaged into the appropriate size tubes, ready for use and are sterilized.



1.5 mL, 4030-PB

Ordering Information				
Catalog #	Description	Color	Pack Qty	Packs Per Case
4030-PB	1.5 mL	Blue	10 per Bag	25 Bags
4040-PB	0.6 mL	Blue	10 per Bag	25 Bags

Made In The USA!



Bio Plas Micro Tube Tool

This handy polypropylene **Micro Tube Tool** opens Snap-Cap and Screw Cap Microcentrifuge Tubes easily, prevents fatigue and saves wear on your fingers and thumbs!

The innovative **Micro Tube Tool** makes it a breeze to open tight-fitting Snap Caps- and it lets you remove Screw Caps while tubes are still in the rack. Convenient and inexpensive, the **Micro Tube Tool** puts an end to difficult maneuvering and straining to open Screw-Cap Tubes and any size Snap Cap Tubes.



Cat# 4000, Micro Tube Tool



The Micro Tube Tool's larger end is a socket wrench for Screw-Cap Micro Tubes.



The Micro Tube Tool's smaller end is used to open a Snap Cap Micro Tubes.

Ordering Information			
Catalog #	Description	Pack Qty	Packs Per Case
4000	Micro Tube Tool	4	25

Micro Tube Tool, Patent # 5,253,551

Made In The USA!

Bio Plas, Inc. A Woman Owned Small Business
www.bioplas.com info@bioplas.com



96 & 64 Well “Reversible” Micro Tube Racks

Both the **96 and 64 Well “Reversible” Micro Tube Racks** are designed so that one side of the rack accommodates 0.5ml microcentrifuge tubes. The reverse side holds 1.5ml to 2.0ml Flat Top Microcentrifuge Tubes and Screw Cap Microcentrifuge Tubes.

The available clear polypropylene cover for the 96 Well “Reversible” Micro Tube Rack provides a snug fit and is tall enough to store most screw cap microcentrifuge tubes. The Rack cover is made of durable polypropylene and can withstand temperatures from -90°C to $+121^{\circ}\text{C}$.

Racks are autoclavable: 15 minutes, 15psi @ 120°C and will withstand freezer storage to -90°C .

Alpha-numeric markings, “A” thru “H” vertically, 1 thru 8 horizontally.

Ordering Information					
64 Well Catalog #	96 Well Catalog #	Description	Color	Pack Qty	Packs Per Case
0080	0090	Micro Tube Rack	Natural	5	4
0081	0091	Micro Tube Rack	Assorted	5	4
0082	0092	Micro Tube Rack	Blue	5	4
0083	0093	Micro Tube Rack	Green	5	4
0084	0094	Micro Tube Rack	Orange	5	4
0085	0095	Micro Tube Rack	Pink	5	4
0086	0096	Micro Tube Rack	Yellow	5	4
0087	0097	Micro Tube Rack	Lavender	5	4
0089	0099	Micro Tube Rack	Black	5	4
N/A	0052	Tube Rack Cover	Natural	5	4



64 Well Micro Tube Rack,
Orange. Cat# 0084



96 Well Micro Tube Rack,
Yellow. Cat# 0096





Bio Plas 80 Well Micro Tube Racks

The **80 Well Micro Tube Racks** are designed with 80 wells in a 16 x 5 configuration with each well numbered for convenient sample identification. Rack dimensions are 9" L x 2 1/16" D with a well diameter of 10.5mm.

Available in 9 colors. This assortment of colors allows lab technologists to color code specific projects and allows for identification of hazardous experiments.

Racks are autoclavable: 15 minutes, 15psi @ 120°C and will withstand freezer storage to -90°C.

Made In The USA!

80 Well Rack Ordering Information

Catalog #	Description	Color	Pack Qty	Packs Per Case
0060	80 Well Micro Tube Rack	Natural	5	4
0061	80 Well Micro Tube Rack,	Assorted	5	4
0062	80 Well Micro Tube Rack	Blue	5	4
0063	80 Well Micro Tube Rack	Green	5	4
0064	80 Well Micro Tube Rack,	Orange	5	4
0065	80 Well Micro Tube Rack	Pink	5	4
0066	80 Well Micro Tube Rack	Yellow	5	4
0067	80 Well Micro Tube Rack	Lavender	5	4
0068	80 Well Micro Tube Rack	Red	5	4
0069	80 Well Micro Tube Rack	Black	5	4





Polyester Foam Test Tube & Micro Tube Racks

Polyester Foam Tube Rack Features:

- Flame Retardant
- Color: Charcoal
- Long wearing
- Chemical and solvent resistant
- Float on H2O bath with full tube and sample
- Ideal for refrigerated or frozen storage samples
- All tubes can be decanted simultaneously
- Low profile: Will not tip over easily
- Lightweight: Weighs less than two ounces
- Holds and locks 50 culture tubes securely
- Holds and locks 30 microcentrifuge and micro blood collecting tubes securely in racks
- More uniform incubation: Tubes may be pushed down into H2O bath while still being held securely in rack
- May be used in blood drawing trays-holds blood drawing tubes securely



Catalog# 0021

Ordering Information

Catalog #	Description	Pack Qty	Packs Per Case
0010	Fits 50 Tubes, sizes: 10 x 75mm, 12 x 75mm, 13 x 100mm	6 Racks	5
0011	Fits 50 Tubes, sizes: 15 x 85mm, 16 x 100mm, 16 x 125mm, 16 x 150mm	6 Racks	5
0020	Fits 50 Tubes, sizes: 250µl , 400µl	6 Racks	5
0021	Fits 50 Tubes, sizes: 500µl , 1.5mL, 1.8mL	6 Racks	5



Catalog# 0011

Made In The USA!



Consumables For Thermal Cycling Procedures

0.2mL Thin-Wall Micro Reaction Tubes & Strip Caps

Designed for use with 96 Well Thermal Cyclers

Thin Wall Micro Reaction Tubes Benefits:

- Tubes provide optimal contact with the sample block, thus ensuring optimal heat transfer
- Prevents cross-contamination
- Provides secure seal for oil-free thermal cycling
- Individual 0.2mL Thin Wall Tubes require an 8 or 12 Strip Cap to seal each Tube individually
- Fabricated from virgin polypropylene
- Highly polished inner surface allows for maximum sample recovery
- Capacity: Recommended maximum volume for Thermal Cycling amplifications is 100uL. Maximum fill volume for post - Thermal Cycling reagent additions to permit mixing is 200uL.
- Tubes and Strip Caps are packaged non-sterile and are autoclavable at 121 degrees C, 15 PSI for 15 minutes. Remove from autoclave immediately
- Strip Tubes and Strip Caps may be easily cut

Ordering Information

Catalog #	Description	Color	Pkg. Qty	Pkgs./Case
5000-1	0.2mL Micro Tubes for Thermal Cycling, Bulk	Natural	1000	12
5000-2	0.2mL Micro Tubes for Thermal Cycling, Bulk	Red	1000	12
5000-3	0.2mL Micro Tubes for Thermal Cycling, Bulk	Yellow	1000	12
5000-4	0.2mL Micro Tubes for Thermal Cycling, Bulk	Blue	1000	12
5000-5	0.2mL Micro Tubes for Thermal Cycling, Bulk	Green	1000	12
5010-1	8 Strip 0.2mL Micro Tubes for Thermal Cycling	Natural	125	12
5010-2	8 Strip 0.2mL Micro Tubes for Thermal Cycling	Red	125	12
5010-3	8 Strip 0.2mL Micro Tubes for Thermal Cycling	Yellow	125	12
5010-4	8 Strip 0.2mL Micro Tubes for Thermal Cycling	Blue	125	12
5010-5	8 Strip 0.2mL Micro Tubes for Thermal Cycling	Green	125	12
5020-1	12 Strip 0.2mL Micro Tubes for Thermal Cycling	Natural	100	12
5020-2	12 Strip 0.2mL Micro Tubes for Thermal Cycling	Red	100	12
5020-3	12 Strip 0.2mL Micro Tubes for Thermal Cycling	Yellow	100	12
5020-4	12 Strip 0.2mL Micro Tubes for Thermal Cycling	Blue	100	12
5020-5	12 Strip 0.2mL Micro Tubes for Thermal Cycling	Green	100	12
5030-1	8 Strip Caps 0.2mL Micro Tubes for Thermal Cycling	Natural	300	12
5035-1	8 Strip Caps 0.2mL Micro Tubes for Thermal Cycling	Natural	130	24
5040-1	12 Strip Caps 0.2mL Micro Tubes for Thermal Cycling	Natural	200	12

Made In The USA!



8 Strip 0.2mL Micro Tubes for Thermal Cycling, Blue, 5010-4



12 Strip 0.2mL Micro Tubes for Thermal Cycling, Green, 5020-5

CAUTION: Tubes are not intended for storage or centrifugation of organic solvents; not intended for use with S 35 radio labelled compounds



Consumables For Thermal Cycling Procedures

96 Well Preparation Racks & 0.2mL & 0.5mL Conical Thin-Wall Micro Reaction Tubes with Attached Caps.

96 Well Preparation Rack Features:

- Designed as preparation and storage racks for any variety of 0.2mL Tubes and Strip Caps before and after sample processing application
- Formatted in the standard 8 x 12 microtiter format
- Identified "A" through "H" vertically, and 1 through 12 horizontally, providing convenient and error free Tube identification
- Transparent plastic cover with new "slip edge" allowing safe storage of multi racks which can maximize bench top space



96 Well Preparation Rack with Cover. Fluorescent Blue, 0030F



5045-2, 0.2mL Tube, Red

Conical Thin Wall Micro Reaction Tubes with Attached Caps Features:

- 0.5 mL Frosted Flat Cap surface for sample inscription
- Tubes fabricated from virgin polypropylene
- Highly polished inner surface allows for maximum sample recovery
- Tubes are autoclavable at 121°C for 15 minutes at 15psi and will withstand freezer storage to -90°C. *Remove Tubes from autoclave immediately*



Multi-Cap Tool, 5050-15

Secure lid closure with the Multi-Cap Tool!
Assists in the closing and opening of PCR Tubes and prevents aerosoling.

Ordering Information

Catalog #	Description	Color	Pack Qty	Packs/ Case
0030F	96 Well Preparation Rack, with Cover	Fluorescent Blue	5	4
0031F	96 Well Preparation Rack, with Cover	Fluorescent Green	5	4
0032F	96 Well Preparation Rack, with Cover	Fluorescent Orange	5	4
0033F	96 Well Preparation Rack, with Cover	Fluorescent Pink	5	4
0034F	96 Well Preparation Rack, with Cover	Fluorescent Yellow	5	4
0035F	96 Well Preparation Rack, with Cover	Fluorescent Assorted	5	4
5045-1	0.2mL Conical Thin Wall Tube	Natural	1000	12
5045-2	0.2mL Conical Thin Wall Tube	Red	1000	12
5045-3	0.2mL Conical Thin Wall Tube	Yellow	1000	12
5045-4	0.2mL Conical Thin Wall Tube	Blue	1000	12
5045-5	0.2mL Conical Thin Wall Tube	Green	1000	12
5050-1	0.5mL Conical Thin Wall Tube	Natural	125	10
5050-2	0.5mL Conical Thin Wall Tube	Red	125	10
5050-3	0.5mL Conical Thin Wall Tube	Yellow	125	10
5050-4	0.5mL Conical Thin Wall Tube	Blue	125	10
5050-5	0.5mL Conical Thin Wall Tube	Green	125	10
5050-15	Bio Plas Multi-Cap Tool	Black	1	1

CAUTION: Tubes are not intended for storage or centrifugation of organic solvents; not intended for use with S 35 radio labelled compounds



BioFlex Flat Top PCR Tubes

Individual PCR Tubes

- Individual PCR tubes feature evaporation-resistant, easy-to-open-and-close lids that prevent sample loss.
- Ultra-thin, uniform wells ensure optimal heat transfer and reaction efficiency.
- Conveniently packaged in reclosable bags to minimize risk of contamination.
- Available in ultra-clear and assorted.
- Certified free of detectable RNase, DNase, DNA, PCR inhibitors, and tested pyrogen-free.



Cat# 5060-1

PCR Strip Tubes And Strip Caps

- Robust linkages make the strips rigid and easy to handle, preventing spills.
- Angularly attached caps prevent lids and hinges from interfering with each other, allowing for easier operation in an SBS format rack.
- Unique two-material white tubes with optically-clear flat caps create the perfect environment for consistent, reliable qPCR performance. White wells offer enhanced fluorescence reflection and optically-clear caps ensure that the fluorescence signal is uninhibited.
- Certified free of detectable RNase, DNase, DNA, PCR inhibitors, and tested pyrogen-free.



Cat# 5060-4



Cat# 5060-5

Angularly attached caps on BioFlex 8-Strip and Snappable tubes prevent cap lids and hinges from interfering with each other, allowing for easier operation in an SBS format rack.



Bio Plas, Inc. A Woman Owned Small Business

www.bioplas.com info@bioplas.com

Tel: (415) 472-3777 Fax: (415) 472-3758



BioFlex Flat Top PCR Tubes

Flat Cap Hinged PCR Tubes & Caps

- Strips of hinged attached caps prevent accidents common with separate caps.
- Optically-clear, flat caps for qPCR.
- Uniform thin walls.
- For use in pharmaceutical industry, food industry, and molecular biology.
- Manufactured from high-quality, virgin polypropylene to ensure purity and provide excellent optical clarity.
- Certified free of detectable RNase, DNase, DNA, PCR inhibitors, and tested pyrogen-free.



Cat# 5060-10



Cat# 5060-9

Ordering Information

Catalog #	Description	Color	Pack Qty	Packs/ Case
5060-1	BioFlex Individual PCR Tube with Frosted Flat Cap, 0.2ml	Clear	1000	10
5060-2	BioFlex Individual PCR Tube with Frosted Flat Cap, 0.2ml	Asst	1000	10
5060-3	BioFlex 8-Strip Tubes with Individually-Attached, Angular, Flat Caps, 0.2ml	Clear	120	10
5060-4	BioFlex 8-Strip Tubes with Individually-Attached, Angular, Flat Caps, 0.2ml	Asst	120	10
5060-5	BioFlex 8-Strip Low-Profile* Tubes with Individually-Attached, Angular, Flat Caps, 0.1ml	Clear	120	10
5060-6	BioFlex 8-Strip Low-Profile* Tubes with Individually-Attached Flat, Angular, Caps, 0.1ml	White	120	10
5060-7	BioFlex 8-Strip PCR Tubes & 8-Strip Flat Caps, 0.2ml	Clear	125	10
5060-8	BioFlex 8-Strip Low-Profile PCR Tubes & 8-Strip Flat Caps, 0.1ml	Clear	125	10
5060-9	BioFlex Snappable 8-Strip Tubes with Individually-Attached Flat Caps, 0.2ml	Clear	120	10
5060-10	BioFlex 8-Strip Tubes with Hinged Attached Flat Caps, 0.2ml	Clear	125	10

* Fast® Cyclers and Lightcycler® compatible.

Bio Plas, Inc. A Woman Owned Small Business

www.bioplas.com info@bioplas.com

Tel: (415) 472-3777 Fax: (415) 472-3758



Bio Plas Astral® Inoculation System



10uL Astral Inoculating Loop, Blue, 7000

“The Ultimate In Accuracy. Every Loop Sterile In Its Own Sealed Chamber.”

The disposable **Bio Plas Astral® Inoculation System** is color coded and consists of the following; 1 uL yellow **Astral Loop**, 10 uL blue Astral Loop and white Astral Streaking Needle. During manufacturing, these Astral Loops are inserted into racks which have 96 individual tubular chambers. When the 96 chambers are filled with the **Astral Loops** they are then hermetically sealed with a thin foil membrane. A dust cover is placed over this 96 chamber rack, heat shrunk, and sterilized by electron beam. Additionally all **Astral Loops** are certified to be free of RNase, DNase, DNA, pyrogens and PCR inhibitors.

The handle is designed to be used with one hand and will easily puncture the membrane attaching itself to the hub of the Astral Loop. It may then be withdrawn from its individual sterile chamber ready to be used for inoculation or streaking. When the inoculation or streaking process is complete, the **Astral Loop or Astral Streaking Needle** may then be ejected off the **Astral Handle**.

This easy to use and ruggedly designed **Astral Handle** may be autoclaved repeatedly, without damage to the handle.

- | STEP 1 | STEP 2 | STEP 3 |
|--|---|--|
| Tip of the Astral Handle
Pierces and penetrates
Sealing film | Astral Handle locks
onto Astral Loop or
Astral Streaking Needle | Astral Handle withdraws sterile
Astral Loop or
Astral Streaking Needle |



Every case of 10
96-rack package is
supplied with a free
Astral Handle.

Autoclavable at 250°F
@ 15psi for 15 mins

This illustration shows the three easy, rapid, steps used to extract a sterile 10uL Astral Loop from its sealed chamber.

Astral is a registered trademarks of Bio Plas, Inc., San Rafael, CA

Bio Plas, Inc. A Woman Owned Small Business
www.bioplas.com info@bioplas.com



Bio Plas Astral[®] Inoculation System

Procedures:

All **Astral Loops** may be used in quantitative procedures such as sampling, urine counts, serial dilutions, and bacteriological inoculation.

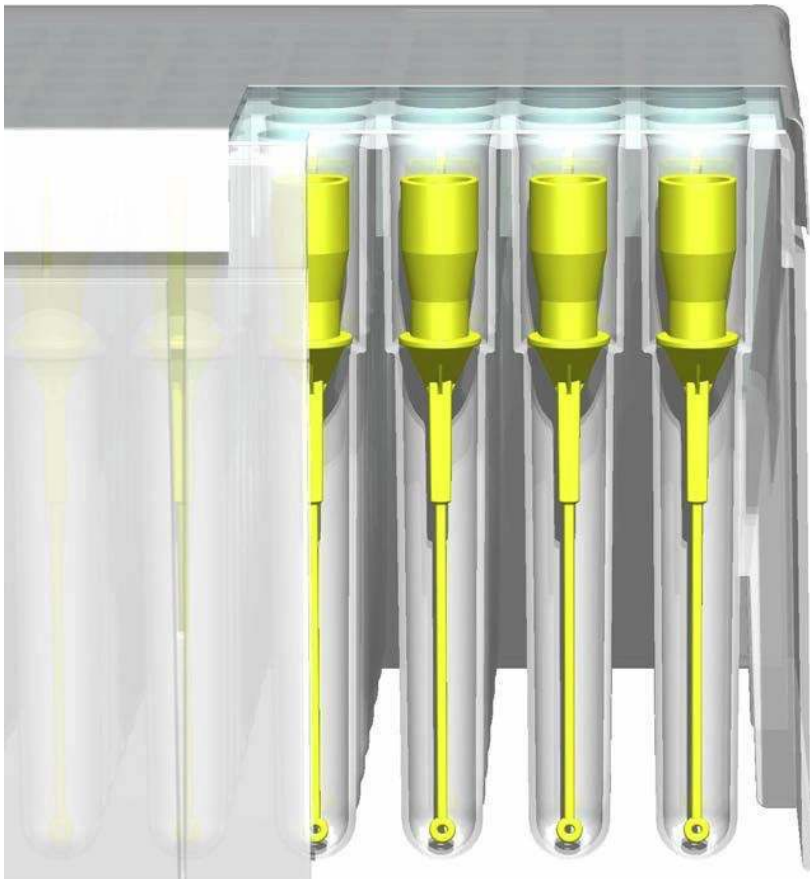

SAFETY: **Astral Loops** eliminate the metal or wire loop flaming step and the hazards of spattering, cross- contamination, and the risk of infectious pathogens caused as a result of aerosols, and the hazards of open flame.

CONVENIENCE: All **Astral Loops** may be quickly extracted from the sterilized rack by using the **Astral Handle**. These **Astral Loops** are flexible enough to facilitate streaking but rigid enough to penetrate the media for inoculation.

TIME SAVINGS: The **Astral Inoculation System** allows the technologist to inoculate prepared plates at an extremely rapid rate in any laboratory setting or condition, i.e., anaerobic chambers, fume hoods, satellite labs or, in the field.

ECONOMY: The savings can be substantial; fewer plates used, guaranteed sterility and cleanliness, zero cross-contamination and speed of use

1uL Astral Inoculating Loop Catalog Number 7000

Autoclavable at 250°F @ 15psi for 15 mins

Astral is a registered trademarks of Bio Plas, Inc., San Rafael, CA

Made In The USA!

Bio Plas, Inc. A Woman Owned Small Business
Tel: (415) 472-3777 Email: info@bioplas.com
www.bioplas.com



Bio Plas Astral® Inoculation System

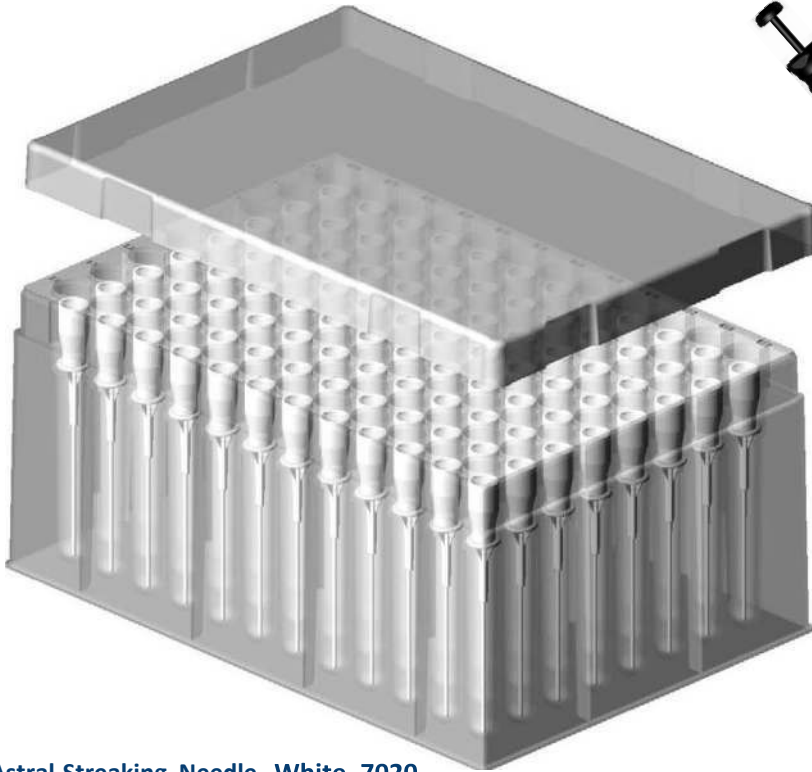

Astral Streaking Needle, White, 7020



Astral Handle, 7050

Every case of 10
96-rack package is supplied
with a free Astral Handle.

Autoclavable at 250°F
@ 15psi for 15 mins

Astral System Ordering Information

Catalog #	Description	Color	Pkg. Qty	Pkgs./Case
7000	1uL Astral Inoculation Loop	Yellow	96/Rack	10
7010	10uL Astral Inoculating Loop	Blue	96/Rack	10
7020	Astral Streaking Needle	White	96/Rack	10
7050	Astral Handle	Black	1	1

Astral is a registered trademarks of Bio Plas, Inc., San Rafael, CA

Bio Plas, Inc. A Woman Owned Small Business
Tel: (415) 472-3777 Email: info@bioplas.com
www.bioplas.com



Bio Plas Bacti Cell Spreaders

The **Bio Plas® Bacti Cell Spreaders** are designed to greatly simplify, and speed up, bacterial culture work. There are two sizes: 30mm and 60mm wide, which allow these polypropylene **Bacti Cell Spreaders** to make it very easy to evenly distribute bacterial cells rapidly over an entire nutrient surface. The **Bacti Cell Spreaders** are individually wrapped (or available in bulk) and may be cleaned and autoclaved for multiple uses.

Bacti Cell Spreader Features:

- Autoclavable, non-breakable (eliminates glass hazard)
- 30mm head for prepared bi-plates
- 60mm head for 100-150mm prepared plates
- Sturdy polypropylene provides uniform design
- Easy to manipulate without slippage
- Easy to manipulate around curves and into corners of prepared plates
- Avoids waste of “disposables” thus becoming an environmental benefit
- Always prevents agar surface tears
- Allows for even distribution of specimen
- Produces an even smear for any permanent slide staining, i.e., PVA preserved fecal specimen for protozoan parasites

Ordering Information

Cat #	Description	Color	Pack Quantity	Packs/Case
6400	30mm Bacti Cell Spreader	Blue	25	4
6401S	30mm Bacti Cell Spreader, Sterile	Blue	25 Individually Wrapped	4
6405	60mm Bacti Cell Spreader	Yellow	25	4
6406S	60mm Bacti Cell Spreader, Sterile	Yellow	25 Individually Wrapped	4

Autoclavable at 250°F @ 15psi for 15 mins

Autoclavable For Repeated Use To Reduce Waste.

An Environmental Benefit.

30mm Bacti Cell Spreader.
Yellow. 6405

30mm Bacti Cell Spreader.
Blue. 6400

Made In The USA!

Bio Plas, Inc. A Woman Owned Small Business
Tel: (415) 472-3777 Email: info@bioplas.com
www.bioplas.com



Histo Plas: Capsettes™ & Uni Capsettes™

Histo Plas™ Capsettes™ and Uni-Capsettes™ provide a modular, organized means for safe and consistent processing, embedding, sectioning and storage of specimen samples. Available in 16 colors which provide a convenient means of separating surgical and autopsy cases, institutions, pathologist, etc. Both the **Histo Plas Capsettes and Uni-Capsettes** are accepted by all of the current automatic cassette labelers.

Cost effective, yet quality engineered to remain sealed during processing. Strategically designed slots allow for efficient solvent flow and drainage, **Histo Plas Capsettes and Uni-Capsettes** will not float during processing. Our rigid design eliminates undersized cassettes during sectioning. Proprietary acetyl copolymer plastic is utilized to resist heat, solvents, decalcifying solutions, and problems associated with microwave processing.

Histo Plas Capsettes and Uni-Capsettes will fit standard stainless steel, and disposable plastic base molds. **Uni-Capsettes** are sold in packages of 500 disposable plastic tops and (500 specimen) bottoms. Technologists no longer need to struggle with detachment of the lid during embedding.

Histo Plas™ Capsettes™ and Uni-Capsettes™ Features:

- Heavy wall Construction will not float
- Will not open during processing
- Available in 16 Colors
- Engineered to eliminate “chatter” during sectioning



Uni-Capsettes™
Orange 6056



Capsettes™ Blue 6034



Uni-Capsettes™ Green 6053



Capsettes™ Yellow 6031

Ordering Information

Uni-Capsettes™ Catalog #	Capsettes™ Catalog #	Description	Color	Pack Qty	Packs/ Case
6050	6030	Uni-Capsettes™/Capsettes™	White	500	10
6051	6031	Uni-Capsettes™/Capsettes™	Yellow	500	10
6052	6032	Uni-Capsettes™/Capsettes™	Pink	500	10
6053	6033	Uni-Capsettes™/Capsettes™	Green	500	10
6054	6034	Uni-Capsettes™/Capsettes™	Blue	500	10
6055	6035	Uni-Capsettes™/Capsettes™	Tan	500	10
6056	6036	Uni-Capsettes™/Capsettes™	Orange	500	10
6057	6037	Uni-Capsettes™/Capsettes™	Lilac	500	10
6058	6038	Uni-Capsettes™/Capsettes™	Gold	500	10
6059	6039	Uni-Capsettes™/Capsettes™	Aqua	500	10
6060	6040	Uni-Capsettes™/Capsettes™	Red	500	10
6061	6041	Uni-Capsettes™/Capsettes™	Chartreuse	500	10
6062	6042	Uni-Capsettes™/Capsettes™	Lime	500	10
6063	6043	Uni-Capsettes™/Capsettes™	Rose	500	10
6064	6044	Uni-Capsettes™/Capsettes™	Peach	500	10
6065	6045	Uni-Capsettes™/Capsettes™	Lavender	500	10

Bio Plas, Inc. A Woman Owned Small Business

www.bioplas.com info@bioplas.com



Histo Plas™ Tissue Processing

Foam Biopsy Pads

The **Foam Biopsy Pads** are fabricated from cellular polyester plastic foam which is manufactured uniformly with air pockets throughout to allow for adequate fluid movement around the tissue while it is securely sandwiched between two pads. This assures the orientation of small biopsy tissue. Available in sizes to fit Tissue Processing Capsules and Capsettes.



Embedding Rings

Tissue is taken from the capsules and placed into stainless steel or plastic base molds. The labeled Embedding Ring is placed atop the base mold, filled with paraffin and cooled. The rings allow for a uniform block and are readily identified when filled. Available in 3 colors for color coding in the laboratory.



Tissue Processing Capsules

For a more economical purchase, the Histo Plas™ disposable, polypropylene Tissue Processing Capsule is the answer. The one piece unit is hinged, perfectly aligned and easy to use. Simply place the tissue in the Capsule and press the cover down to lock securely. The open mesh construction affords maximum fluid exchange during processing and the durable marking surface assures permanent identification. To embed from the capsule we recommend the tissue Embedding Ring system.



Ordering Information				
Catalog #	Description	Color	Pack Qty	Packs/Case
6100	Foam Biopsy Pads (Use with 38mm Capsules)	Blue	1000	10
6110	Foam Biopsy Pads (Use with 29mm Capsules)	Blue	1000	10
6120	Foam Biopsy Pads (Use with 1 x 1 1/4 Cassettes)	Blue	1000	10
6001	Embedding Rings	Yellow	500	10
6002	Embedding Rings	Pink	500	10
6003	Embedding Rings	Green	500	10
6010	Tissue Processing Capsules, 38 x 8	White	500	10
6020	Tissue Processing Capsules, 39 x 6	White	500	10

Made In The USA!

Bio Plas, Inc. A Woman Owned Small Business
 Tel: (415) 472-3777 Email: info@bioplas.com
www.bioplas.com



Bio Plas Pipet Tips

Reference Tips

Reference Pipet Tips				Reference Slim Pipet Tips			
A – 1-250 uL		B – 101-1000 uL		C – 1-200 uL		D – 101-1000 uL	
Replacement for: Eppendorf® 1-100 uL Pipetman™ 1-200 uL Finnpiptette 1-250 uL Socorex 5-100 uL		Replacement for: Oxford® 200-1000 uL Eppendorf® 101-1000 uL Pipetman™ 200-1000 uL Finnpiptette 200-1000 uL Socorex 101-1000 uL		Replacement for: Oxford® Series: 8000 10-200 uL 9000 Model Q 10-200 uL P-7000 1-200 uL 3000 Adjustable Abbott 1-200 uL Helena Quickpette 10-200 uL		Replacement for: Oxford® Series: 8000 600-1000 uL 9000 Model Q 600-1000 uL P-7000 200-1000 uL 3000 Adjustable Abbott 600-1000 uL Helena Quickpette 501-1000 uL	

Ordering Information

A				B				C				D			
Catalog #	Tips/Rack	Tips/Pkg	Pkgs/Cs	Catalog #	Tips/Rack	Tips/Pkg	Pkgs/Cs	Catalog #	Tips/Rack	Tips/Pkg	Pkgs/Cs	Catalog #	Tips/Rack	Tips/Pkg	Pkgs/Cs
0001	N/A	1000	10	0002	N/A	1000	10	1012	N/A	1000	10	1212	N/A	1000	10
0001R	250	1000	10	0002R	250	1000	10	1012R	250	1000	10	1212R	250	1000	10

Made In The USA!

Bio Plas, Inc. A Woman Owned Small Business
 Tel: (415) 472-3777 Email: info@bioplas.com
www.bioplas.com



Uni-Tip™ Universal Pipet Tips

Racked pipet tips allow the user to mount pipet tips in one efficient motion. The rack design features a seamless bottom that does not “breathe in” bench debris and contaminate tips when rack lid is opened. Racks are autoclavable at 250° F for 15 minutes at 15 psi.

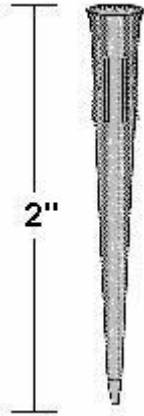
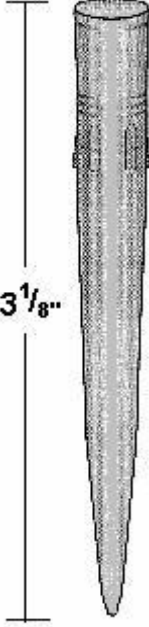
1 – 250 uL	101 – 1000 uL
 <p>Replacement for:</p> <ul style="list-style-type: none"> Eppendorf® 1-100 uL Pipetman™ 1-200 uL Finnpipette 1-250 uL Socorex 5-100 uL 	 <p>Replacement for:</p> <ul style="list-style-type: none"> Eppendorf® 101-1000 uL Pipetman™ 200-1000 uL Oxford® 200-1000 uL Finnpipette 200-1000 uL Socorex 101-1000 uL

Uni-Tips™ Benefits:

- Fit Multiple Brand Name Ejector Models
- Inventory Reduction
- Rimless
- Racked or In Bulk

Made In The USA!

Ordering Information

Catalog #	Tips/Rack	Tips/Pkg	Pkg/Cs	Catalog #	Tips/Rack	Tips/Pkg	Pkg/Cs
0003	N/A	1000	10	0004	N/A	1000	10
0003R	250	1000	10	0004R	250	1000	10

Bio Plas, Inc. A Woman Owned Small Business
 Tel: (415) 472-3777 Email: info@bioplas.com
www.bioplas.com



Economical Alternatives to Brand Name Pipet Tips

Made from virgin, non-wettable polypropylene, these tips are designed to replace specific manufacturer's tips.

For easy selection of replacement tips for your particular brand pipettor:

1. Find the brand you are currently using on the chart below. Example: Eppendorf®.
2. Find the tip volume. Example: 1-100 uL
3. Find the Tip Code at the bottom of the chart and use the code to locate the diagram and catalog number for the replacement tip in the charts on the following pages.







BRAND NAME CROSS REFERENCE																			
Manufacturer/Brand	Tip Volume Range, uL																		
C/A Selecapette																			
Eppendorf®	1-100	101-1000																	
Finnpipette			1-250	200-1000															
Gilson Pipetman™					1-200	200-1000													
MLA®							10-200	250-1000											
Multi-Channel Titertek® and Octapette®										1-250									
Oxford®											5-200	1-200	250-500	600-1000	250-1000				
Oxford® Slim Tip												1-200			250-1000				
Sherwood/Lancer																5-			
Wheaton/Socorex																		5-100	101-1000
Tip Code	A	B	C	D	E	F	G	H	I	J	K	L	M	N	O	P	Q	R	

Made In The USA!

Bio Plas, Inc. A Woman Owned Small Business
 Tel: (415) 472-3777 Email: info@bioplas.com
www.bioplas.com



Economical Alternatives to Brand Name Pipet Tips









REPLACEMENT TIP CHART			Catalog Numbers			
Tip Code	Diagram	Length (Inches)	Wells Per Rack	Racks Per Pkg	Racked Cat#	Bag of 1000 Cat#
B	 Yellow	2	250	4	1300R	1300
C	 Blue	3 ½	250	4	1400R	1400
D	 Natural	2	250	4	2400R	2400
E	 Green	3 ½	250	4	2500R	2500
F	 Yellow	2	250	4	2000R	2000
G	 Blue	3 ½	250	4	2100R	2100
H	 Natural	1 ½	250	4	1600R	1600

Made In The USA!

Bio Plas, Inc. A Woman Owned Small Business
 Tel: (415) 472-3777 Email: info@bioplas.com
www.bioplas.com



Economical Alternatives to Brand Name Pipet Tips

REPLACEMENT TIP CHART			Catalog Numbers			
Tip Code	Diagram	Length In.	Wells/Rack	Racks /pkg.	Racked	Bag (1000)
J	 Natural	2	96	10	3500R	3500
K	 Natural	1 3/4	250	4	1000R	1000
L	 Natural	2 3/4	250	4	1010R	1010
M	 Yellow	2 3/16				1100
N	 Green	3 3/4	250	4	1200R	1200
O	 Blue	3	250	4	1211R	1211
P	 Natural	2 3/4				1500
Q	 Yellow	2	250	4	2600R	2600
R	 Blue	1 3/4	250	4	2700R	2700

Made In The USA!

Bio Plas, Inc. A Woman Owned Small Business
 Tel: (415) 472-3777 Email: info@bioplas.com
www.bioplas.com



Ultra-Micro Pipet Tips

Designed to fit the full range of Eppendorf®, Pipetman™ and Oxford® Benchmate® Ultra Micro Pipetters.

Thin, tapered, delivery end eliminates carryover during pipetting. Manufactured with natural virgin polypropylene and warranted to be trace metal free. Racked pipet tips allow the user to mount pipet tips in one efficient motion. The rack design features a seamless bottom that does not “breathe in” bench debris and contaminate tips when rack lid is opened. Racks are autoclavable at 250° F for 15 minutes at 15 psi.

0.1 – 10 uL	
	<p>Replacement for:</p> <p>Pipetman™</p> <p>Model P-2 0.1-2.0 uL</p> <p>Model P-10 0.5-10 uL</p>

Ordering Information			
Catalog #	Tips/Rack	Tips/Pkg	Pkg.Cs
2010	N/A	1000	10

Made In The USA!

Bio Plas, Inc. A Woman Owned Small Business
 Tel: (415) 472-3777 Email: info@bioplas.com
www.bioplas.com



Siliconized Pipet Tips

Universal fit that will provide an absolute seal on these single channel pipettors. Siliconized Pipet Tips are NOT recommended for autoclaving.

Siliconized Pipet Tips Benefits:

- Specially formatted siliconized polypropylene to help eliminate sample residue and cross-contamination
- Allows for precise and complete sample delivery
- Ideal for use in DNA and Thermal Cycling Procedures
- Low adhesion surface assures complete transfer of samples
- Prevents protein or nucleic acid adherence

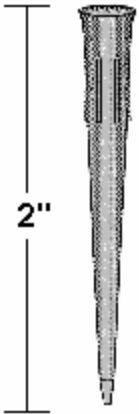
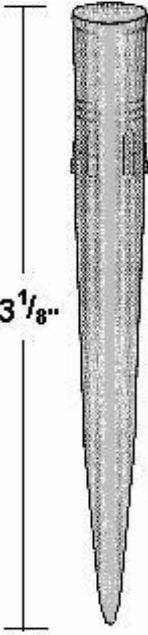
1 – 200 μ L		100 – 1000 μ L	
	<p>Replacement for:</p> <p>Eppendorf® 1-100 μL</p> <p>Pipetman™ 1-200 μL</p> <p>Finnpipette 1-250 μL</p> <p>Socorex 5-100 μL</p>		<p>Replacement for:</p> <p>Eppendorf® 101-1000 μL</p> <p>Pipetman™ 200-1000 μL</p> <p>Oxford® 250-1000 μL</p> <p>Finnpipette 200-1000 μL</p> <p>Socorex 101-1000 μL</p>

Ordering Information

Catalog #	Tips/Rack	Tips/Pkg	Pkg.Cs	Catalog #	Tips/Rack	Tips/Pkg	Pkg.Cs
3600SL	N/A	500	20	3605SL	N/A	500	20
3601SRS1	96	960	1	3606SRS1	100	1000	1



Contact Information

Sales & Product Information:

Email: bill@bioplas.com

Tel: (613) 558-8530

Purchase Orders:

Email: orders@bioplas.com

Fax: (415) 472-3758

Order Status:

Email: orders@bioplas.com

Tel: (415) 472-3777

Invoice Payments:

Email: payments@bioplas.com

Accounts Receivable & Invoices:

Email: mollie@bioplas.com

Tel: (415) 472-3777

Bio Plas, Inc.

4380 Redwood Highway

Suite C-16

San Rafael, CA 94903

Tel: (415) 472-3777

Fax: (415) 472-3758

Email: Info@BioPlas.com