

Neosys Technology Inc.

POC-300 Series

User Manual

Revision 1.1

Table of Contents

Table of Contents	2
Legal Information	5
Contact Information	6
Declaration of Conformity	6
Copyright Notice	7
Safety Precautions	8
Service and Maintenance	9
ESD Precautions	9
About This Manual	10

1 Introduction

1.1 Specification of POC-300	12
1.2 Specification of POC-310	14
1.3 Specification of POC-320	16
1.4 Specification of POC-330	18
1.5 Dimension	20
1.5.1 Superior View	20
1.5.2 Front Panel View	21
1.5.3 Bottom View	22
1.6 POC-300 Series Mounting Options	23
1.6.1 DIN-Rail Mount Clip	23
1.6.2 Wall Mount Bracket (WM-300V)	24
1.6.3 Wall Mount Bracket (WM-300H)	25

2 System Overview

2.1 Unpacking the System	26
2.2 POC-300 Series Front Panel	27
2.2.1 USB 2.0 Port	28
2.2.2 Power Button	29
2.2.3 Reset Button	30
2.2.4 Gigabit Ethernet	31
2.2.5 System Status LED	32
2.2.6 DVI-I Port	33
2.2.7 USB 3.0 Port	34
2.2.8 IEEE 802.3at Power over Ethernet Port #1 & #2 (POC-300/ POC-320 Only) ...	35
2.2.9 3-Pin Terminal Block for DC Input/ Ignition Input	36
2.3 POC-300 Series Top Panel	37
2.3.1 COM Port (COM1)	38
2.3.2 COM Ports (COM2/ COM3/ COM4)	39
2.3.3 3.5mm Microphone-in/ Speaker-out Jack	40
2.3.4 SMA Antennae Opening	41
2.4 POC-300 Series Internal I/O	42
2.4.1 DDR3L SO-DIMM Socket	42
2.4.2 Full-size mini-PCIe Socket	43
2.4.3 Half-size mSATA Socket	45
2.5 MeziO™ Interface	47
2.5.1 MeziO™ Interface Pin Definition	48
2.5.2 MeziO™ Modules for POC-300 Series	49

3 System Installation

3.1 Disassembling the System Enclosure	51
3.2 Installing Internal Components	52
3.2.1 DDR3L SO-DIMM Installation	52
3.2.2 mini-PCIe Module, SIM Card and Antennae Installation	53

3.2.3	mSATA Module Installation	57
3.2.4	2.5" HDD/ SSD Installation (for MeziO-R11/ R12)	59
3.2.5	MeziO™ Module Installation	60
3.3	Installing the System Enclosure	62
3.4	DIN Rail Installation.....	63
3.5	Wall Mount Bracket Installation (with WM-300V).....	65
3.6	Wall Mount Bracket Installation (with WM-300H).....	67
3.7	Powering On the System	70
3.7.1	Powering On Using the Power Button.....	70
3.7.2	Powering On Using An External Non-Latched Switch.....	71
3.7.3	Powering On Using An External Latched Switch.....	72
3.7.4	Powering On Using Wake-on-LAN.....	73
3.8	Ignition Power Control (For MeziO-V20 Only).....	76
3.8.1	Principles of Ignition Power Control	76
3.8.2	Additional Features of Ignition Power Control	77
3.8.3	Wiring Ignition Signal	78
3.8.4	Configure your Windows system.....	79
3.8.5	Operation Modes of Ignition Power Control	80
4	BIOS Settings	
4.1	COM1 Port Configuration	83
4.2	COM2/ 3/ 4 Port Configuration	84
4.3	SATA Interface Speed.....	85
4.4	C-States	86
4.5	Wake-on-LAN	87
4.6	Power On after Power Failure.....	88
4.7	Position New Boot Device	89
4.8	Watchdog Timer.....	90
4.9	Select a Boot Device	91
5	OS Support and Driver Installation	
5.1	Operating System Compatibility	92
5.2	Driver Installation	93
5.2.1	Install Drivers Automatically	93
5.2.2	Install Drivers Manually.....	94
5.3	Driver for Watchdog Timer and DIO.....	95
Appendix A Using WDT & DIO		
WDT and DIO Library Installation		97
WDT Function Reference		99
InitWDT		99
SetWDT.....		99
StartWDT.....		100
ResetWDT.....		100
StopWDT.....		100
Using DIO Function (With MeziO-R12 Installed).....		101
Wiring for DIO.....		101
DIO Pin Definition.....		102
DIO Function Reference		103
InitDIO		103
DIReadLine		103
DIReadPort		103
DOWriteLine.....		104
DOWritePort.....		104
DOWriteLineChecked.....		105
DOWritePortChecked.....		105
COS Function Reference.....		106
SetupDICOS		106
RegisterCallbackDICOS.....		107
StartDICOS.....		107

Table of Contents

StopDICOS.....	108
DI COS Example.....	108

Legal Information

All Neosys Technology Inc. products shall be subject to the latest Standard Warranty Policy

Neosys Technology Inc. may modify, update or upgrade the software, firmware or any accompanying user documentation without any prior notice. Neosys Technology Inc. will provide access to these new software, firmware or documentation releases from download sections of our website or through our service partners.

Before installing any software, applications or components provided by a third party, customer should ensure that they are compatible and interoperable with Neosys Technology Inc. product by checking in advance with Neosys Technology Inc. Customer is solely responsible for ensuring the compatibility and interoperability of the third party's products. Customer is further solely responsible for ensuring its systems, software, and data are adequately backed up as a precaution against possible failures, alternation, or loss.

For questions in regards to hardware/ software compatibility, customers should contact Neosys Technology Inc. sales representative or technical support.

To the extent permitted by applicable laws, Neosys Technology Inc. shall NOT be responsible for any interoperability or compatibility issues that may arise when (1) products, software, or options not certified and supported; (2) configurations not certified and supported are used; (3) parts intended for one system is installed in another system of different make or model.

Contact Information

Headquarters
(Taipei, Taiwan) **Neosys Technology Inc.**
15F, No.868-3, Zhongzheng Rd., Zhonghe Dist., New Taipei City, 23586, Taiwan
Tel: +886-2-2223-6182 Fax: +886-2-2223-6183 [Email](#), [Website](#)

Americas
(Illinois, USA) **Neosys Technology America Inc.**
3384 Commercial Avenue, Northbrook, IL 60062, USA
Tel: +1-847-656-3298 [Email](#), [Website](#)

China **Neosys Technology (China) Ltd.**
Room 612, Building 32, Guiping Road 680, Shanghai
Tel: +86-2161155366 [Email](#), [Website](#)

Declaration of Conformity

FCC This equipment has been tested and found to comply with the limits for a Class A digital device, pursuant to part 15 of the FCC Rules. These limits are designed to provide reasonable protection against harmful interference when the equipment is operated in a commercial environment. This equipment generates, uses, and can radiate radio frequency energy and, if not installed and used in accordance with the instruction manual, may cause harmful interference to radio communications. Operation of this equipment in a residential area is likely to cause harmful interference in which case the user will be required to correct the interference at own expense.

CE The product(s) described in this manual complies with all applicable European Union (CE) directives if it has a CE marking. For computer systems to remain CE compliant, only CE-compliant parts may be used. Maintaining CE compliance also requires proper cable and cabling techniques.

Copyright Notice

All rights reserved. This publication may not be reproduced, transmitted, transcribed, stored in a retrieval system, or translated into any language or computer language, in any form or by any means, electronic, mechanical, magnetic, optical, chemical, manual or otherwise, without the prior written consent of Neosys Technology, Inc.

Disclaimer

This manual is intended to be used as an informative guide only and is subject to change without prior notice. It does not represent commitment from Neosys Technology Inc. Neosys Technology Inc. shall not be liable for any direct, indirect, special, incidental, or consequential damages arising from the use of the product or documentation, nor for any infringement on third party rights.

Patents and Trademarks

Neosys, the Neosys logo, Expansion Cassette, MezIO™ are registered patents and trademarks of Neosys Technology, Inc.

Windows is a registered trademark of Microsoft Corporation.

Intel®, Core™ are registered trademarks of Intel Corporation

NVIDIA®, GeForce® are registered trademarks of NVIDIA Corporation

All other names, brands, products or services are trademarks or registered trademarks of their respective owners.

Safety Precautions

- Read these instructions carefully before you install, operate, or transport the system.
- Install the system or DIN rail associated with, at a sturdy location
- Install the power socket outlet near the system where it is easily accessible
- Secure each system module(s) using its retaining screws
- Place power cords and other connection cables away from foot traffic. Do not place items over power cords and make sure they do not rest against data cables
- Shutdown, disconnect all cables from the system and ground yourself before touching internal modules
- Ensure that the correct power range is being used before powering the device
- Should a module fail, arrange for a replacement as soon as possible to minimize down-time
- If the system is not going to be used for a long time, disconnect it from mains (power socket) to avoid transient over-voltage

Service and Maintenance

- ONLY qualified personnel should service the system
- Shutdown the system, disconnect the power cord and all other connections before servicing the system
- When replacing/ installing additional components (expansion card, memory module, etc.), insert them as gently as possible while assuring proper connector engagement

ESD Precautions

- Handle add-on module, motherboard by their retention screws or the module's frame/ heat sink. Avoid touching the PCB circuit board or add-on module connector pins
- Use a grounded wrist strap and an anti-static work pad to discharge static electricity when installing or maintaining the system
- Avoid dust, debris, carpets, plastic, vinyl and styrofoam in your work area.
- Do not remove any module or component from its anti-static bag before installation

About This Manual

This manual introduces and demonstrates installation procedures of Neosys POC-300 series systems.

Revision History

Version	Date	Description
1.0	Nov. 2017	Initial release
1.1	May. 2018	Added POC-300 power consumption figure Added POC-310 power consumption figure. Added POC-320 power consumption figure Added POC-330 power consumption figure Updated MezIO-R12 DIO pin definition

1 Introduction

Neosys Technology POC-300 series are ultra-compact fanless embedded computers featuring Intel® Apollo-Lake Atom™ x7-E3950 or Pentium® N4200 processor. The latest member of Neosys' ultra-compact POC series (POC-300) has a compact and rugged chassis with dimensions measuring just 56 (W) x 153 (H) x 108 (D) mm. Designed for DIN rail mounting with front panel I/O port access, POC-300 is easy to setup and ideal for industrial applications where space is limited.

POC-300 series system utilizes Intel Atom™ x7-E3950 quad-core processor that features an updated 14nm microarchitecture with integrated HD graphics and faster memory speeds (DDR3L-1866) for efficient computing. It delivers more than 150% CPU performance and 300% GPU performance over previous E3800 series platform. For applications such as industrial automation, machine vision and real-time surveillance can all benefit from its higher throughput performance.



Neosys POC-300 series provides rich I/O ports, it has one Gigabit Ethernet port, two 802.3at Gigabit PoE+ ports, two USB3.0 ports, two USB2.0 ports, one DVI-I connector for VGA + DVI dual video output, four COM ports and is compatible with Neosys' MezIO™ interface.

Neosys MezIO interface allows for the installation of an I/O expansion module that is application-oriented. The expansion module is a flexible and cost-effective way to customize an embedded system for dedicated applications.

As an industrial embedded computer, POC-300 series systems can function under 100% CPU load under wide temperature ranging from -25°C to 70°C. It also accepts a wider range of power inputs from 8 to 35V DC and is fully tested for 24/7 operation in harsh environments.

1.1 Specification of POC-300

System Core	
Processor	Intel® Atom™ E3950 1.6/ 2.0GHz quad-core processor
Graphics	Integrated Intel® HD Graphics 505
Memory	1x SODIMM socket for DDR3L-1866, up to 8GB
Panel I/O Interface	
Ethernet	3x Gigabit Ethernet ports by Intel® I210 GbE controller
PoE	IEEE 802.3at PoE+ on port #1 and #2
Video Port	1x DVI-I connector for both analog RGB and DVI outputs, supporting up to 1920 x 1200 resolution
Serial Port	1x programmable RS-232/ 422/ 485 port (COM1) 3x 3-wire RS-232 ports (COM2/ 3/ 4) or 1x RS-422/ 485 port (COM2)
USB	2x USB 3.0 ports 2x USB 2.0 ports
Audio	1x speaker-out 1x microphone-in
Internal I/O Interface	
Mini-PCIe	1x full-size mini PCI Express slot with USIM socket
Storage Interface	
mSATA	1x half-size mSATA port
Power Supply	
DC Input	Built-in 8~35 VDC DC input
Input Connector	3-pin pluggable terminal block for DC input
Max. Power consumption	19.68W (0.82A@24V)*
Mechanical	
Dimension	56 x 108 x 153 mm
Weight	0.96 kg
Mounting	DIN-rail mount (Standard) Wall-mount (Optional)
Environmental	
Operating Temperature	-25°C ~ 70°C with SSD, 100% CPU loading */**
Storage Temperature	-40°C ~85°C

Humidity	10%~90% , non-condensing
Vibration	Operating, 5 Grms, 5-500 Hz, 3 Axes (w/ SSD, according to IEC60068-2-64)
Shock	Operating, 50 Grms, Half-sine 11 ms Duration (w/ SSD, according to IEC60068-2-27)
EMC	CE/FCC Class A, according to EN 55022 & EN 55024

** The 100% CPU/GPU loading for high temperature test is applied using Passmark® BurnInTest™ v8.0. For detail testing criteria, please contact Neousys Technology*

*** For sub-zero operating temperature, a wide temperature HDD drive or Solid State Disk (SSD) is required.*

1.2 Specification of POC-310

System Core	
Processor	Intel® Atom™ E3950 1.6/ 2.0GHz quad-core processor
Graphics	Integrated Intel® HD Graphics 505
Memory	1x SODIMM socket for DDR3L-1866, up to 8GB
Panel I/O Interface	
Ethernet	3x Gigabit Ethernet ports by Intel® I210 GbE controller
Video Port	1x DVI-I connector for both analog RGB and DVI outputs, supporting up to 1920 x 1200 resolution
Serial Port	1x programmable RS-232/ 422/ 485 port (COM1) 3x 3-wire RS-232 ports (COM2/ 3/ 4) or 1x RS-422/ 485 port (COM2)
USB	2x USB 3.0 ports 2x USB 2.0 ports
Audio	1x speaker-out 1x microphone-in
Internal I/O Interface	
Mini-PCIe	1x full-size mini PCI Express slot with USIM socket
Storage Interface	
mSATA	1x half-size mSATA port
Power Supply	
DC Input	Built-in 8~35 VDC DC input
Input Connector	3-pin pluggable terminal block for DC input
Max. Power consumption	19.68W (0.82A@24V)*
Mechanical	
Dimension	56 x 108 x 153 mm
Weight	0.96 kg
Mounting	DIN-rail mount (Standard) Wall-mount (Optional)
Environmental	
Operating Temperature	Operating temperature: -25°C ~ 70°C with SSD, 100% CPU loading */**
Storage Temperature	-40°C ~85°C
Humidity	10%~90% , non-condensing

Vibration	Operating, 5 Grms, 5-500 Hz, 3 Axes (w/ SSD, according to IEC60068-2-64)
Shock	Operating, 50 Grms, Half-sine 11 ms Duration (w/ SSD, according to IEC60068-2-27)
EMC	CE/FCC Class A, according to EN 55022 & EN 55024

** The 100% CPU/GPU loading for high temperature test is applied using Passmark® BurnInTest™ v8.0. For detail testing criteria, please contact Neosys Technology*

*** For sub-zero operating temperature, a wide temperature HDD drive or Solid State Disk (SSD) is required.*

1.3 Specification of POC-320

System Core	
Processor	Intel® Pentium® N4200 1.1/ 2.5GHz quad-core processor
Graphics	Integrated Intel® HD Graphics 505
Memory	1x SODIMM socket for DDR3L-1866, up to 8GB
Panel I/O Interface	
Ethernet	3x Gigabit Ethernet ports by Intel® I210 GbE controller
PoE	IEEE 802.3at PoE+ on port #1 and #2
Video Port	1x DVI-I connector for both analog RGB and DVI outputs, supporting up to 1920 x 1200 resolution
Serial Port	1x programmable RS-232/ 422/ 485 port (COM1) 3x 3-wire RS-232 ports (COM2/ 3/ 4) or 1x RS-422/ 485 port (COM2)
USB	2x USB 3.0 ports 2x USB 2.0 ports
Audio	1x speaker-out 1x microphone-in
Internal I/O Interface	
Mini-PCIe	1x full-size mini PCI Express slot with USIM socket
Storage Interface	
mSATA	1x half-size mSATA port
Power Supply	
DC Input	Built-in 8~35 VDC DC input
Input Connector	3-pin pluggable terminal block for DC input
Max. Power consumption	14.16W (0.59A@24V)*
Mechanical	
Dimension	56 x 108 x 153 mm
Weight	0.96 kg
Mounting	DIN-rail mount (Standard) Wall-mount (Optional)
Environmental	
Operating Temperature	-25°C ~ 70°C with SSD, 100% CPU loading */**
Storage Temperature	-40°C ~85°C

Humidity	10%~90% , non-condensing
Vibration	Operating, 5 Grms, 5-500 Hz, 3 Axes (w/ SSD, according to IEC60068-2-64)
Shock	Operating, 50 Grms, Half-sine 11 ms Duration (w/ SSD, according to IEC60068-2-27)
EMC	CE/FCC Class A, according to EN 55022 & EN 55024

** The 100% CPU/GPU loading for high temperature test is applied using Passmark® BurnInTest™ v8.0. For detail testing criteria, please contact Neosys Technology*

*** For sub-zero operating temperature, a wide temperature HDD drive or Solid State Disk (SSD) is required.*

1.4 Specification of POC-330

System Core	
Processor	Intel® Pentium® N4200 1.1/ 2.5GHz quad-core processor
Graphics	Integrated Intel® HD Graphics 505
Memory	1x SODIMM socket for DDR3L-1866, up to 8GB
Panel I/O Interface	
Ethernet	3x Gigabit Ethernet ports by Intel® I210 GbE controller
Video Port	1x DVI-I connector for both analog RGB and DVI outputs, supporting up to 1920 x 1200 resolution
Serial Port	1x programmable RS-232/ 422/ 485 port (COM1) 3x 3-wire RS-232 ports (COM2/ 3/ 4) or 1x RS-422/ 485 port (COM2)
USB	2x USB 3.0 ports 2x USB 2.0 ports
Audio	1x speaker-out 1x microphone-in
Internal I/O Interface	
Mini-PCIe	1x full-size mini PCI Express slot with USIM socket
Storage Interface	
mSATA	1x half-size mSATA port
Power Supply	
DC Input	Built-in 8~35 VDC DC input
Input Connector	3-pin pluggable terminal block for DC input
Max. Power consumption	14.16W (0.59A@24V)*
Mechanical	
Dimension	56 x 108 x 153 mm
Weight	0.96 kg
Mounting	DIN-rail mount (Standard) Wall-mount (Optional)
Environmental	
Operating Temperature	-25°C ~ 70°C with SSD, 100% CPU loading */**
Storage Temperature	-40°C ~85°C
Humidity	10%~90% , non-condensing

Vibration	Operating, 5 Grms, 5-500 Hz, 3 Axes (w/ SSD, according to IEC60068-2-64)
Shock	Operating, 50 Grms, Half-sine 11 ms Duration (w/ SSD, according to IEC60068-2-27)
EMC	CE/FCC Class A, according to EN 55022 & EN 55024

** The 100% CPU/GPU loading for high temperature test is applied using Passmark® BurnInTest™ v8.0. For detail testing criteria, please contact Neosys Technology*

*** For sub-zero operating temperature, a wide temperature HDD drive or Solid State Disk (SSD) is required.*

1.5 Dimension

1.5.1 Superior View

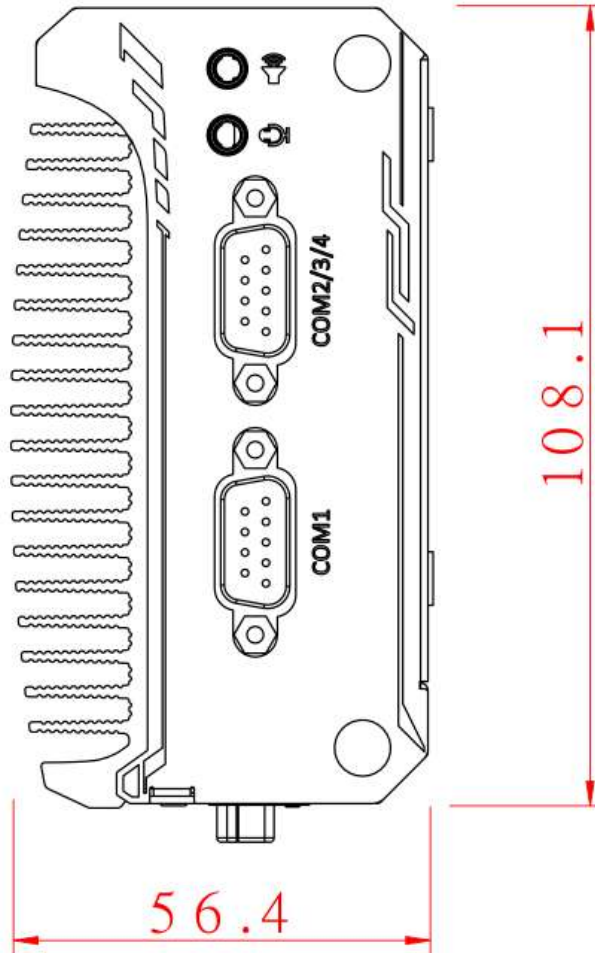

1.5.2 Front Panel View

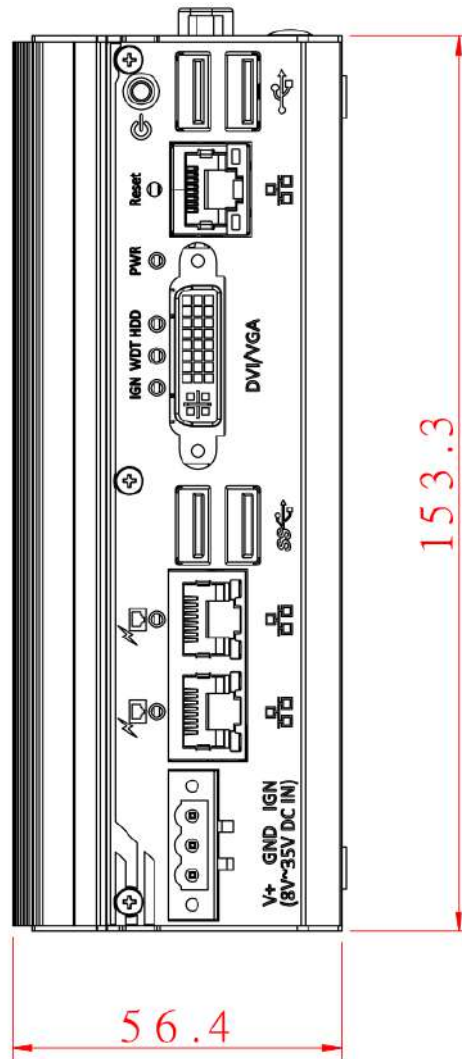

1.5.3 Bottom View

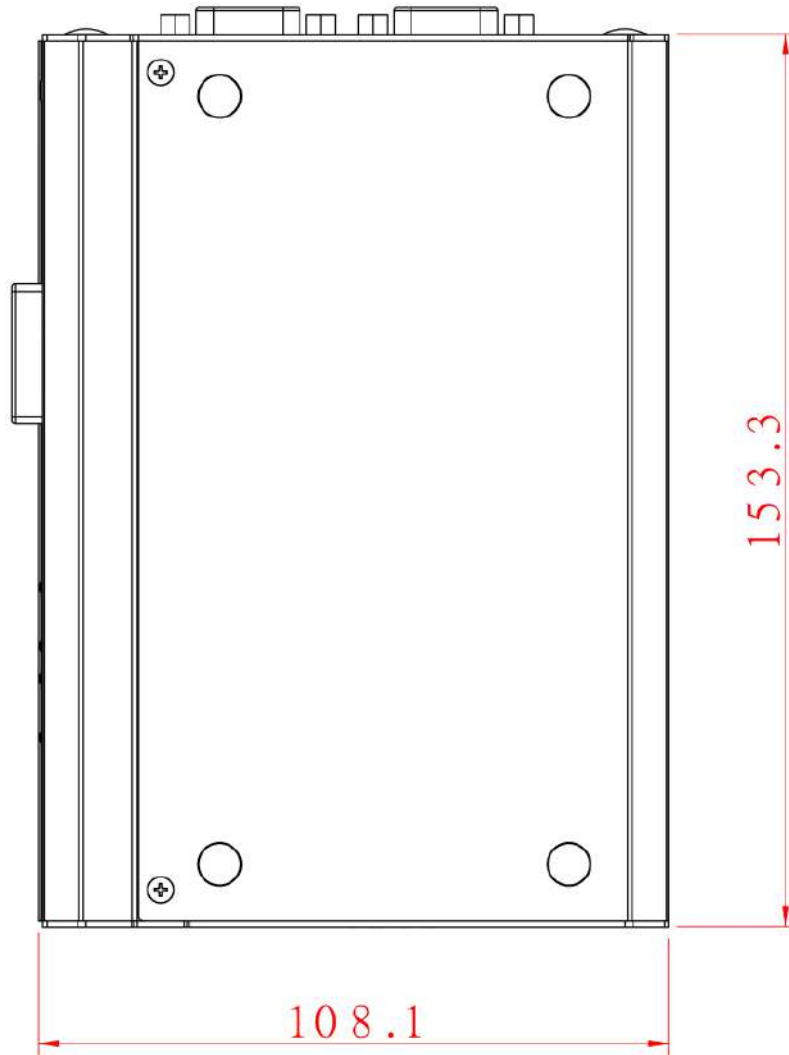

1.6 POC-300 Series Mounting Options

The system comes with various mounting options such as DIN-rail and wall-mount bracket. DIN-rail mount clip is shipped with POC-300 series as standard mounting option. Two optional mounting brackets, WM-300V and WM-300H, are available for wall-mount applications.

1.6.1 DIN-Rail Mount Clip

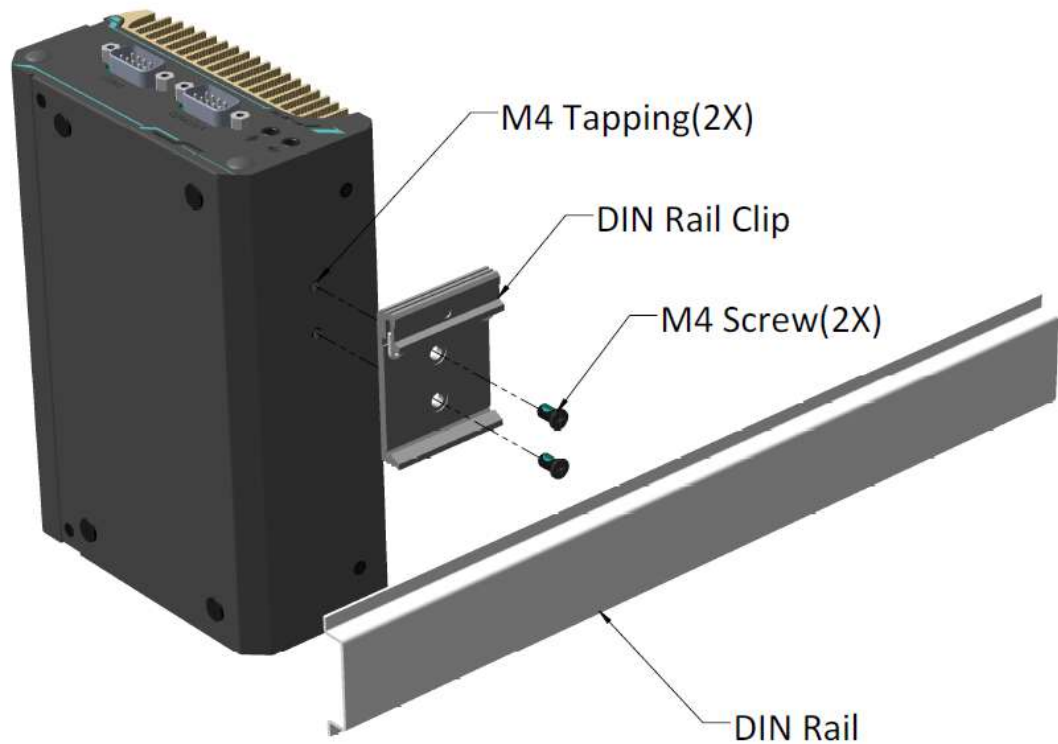

1.6.2 Wall Mount Bracket (WM-300V)

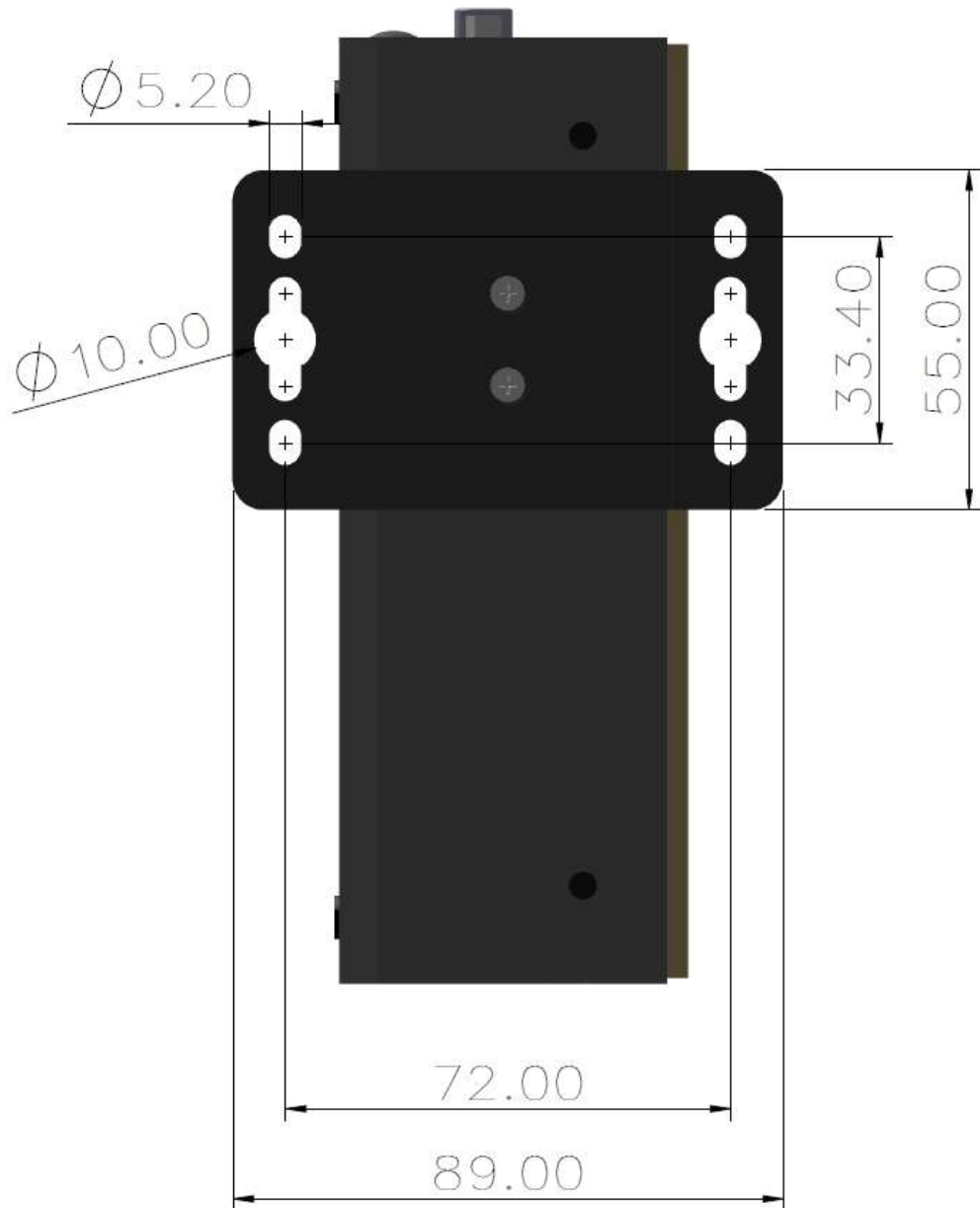

1.6.3 Wall Mount Bracket (WM-300H)

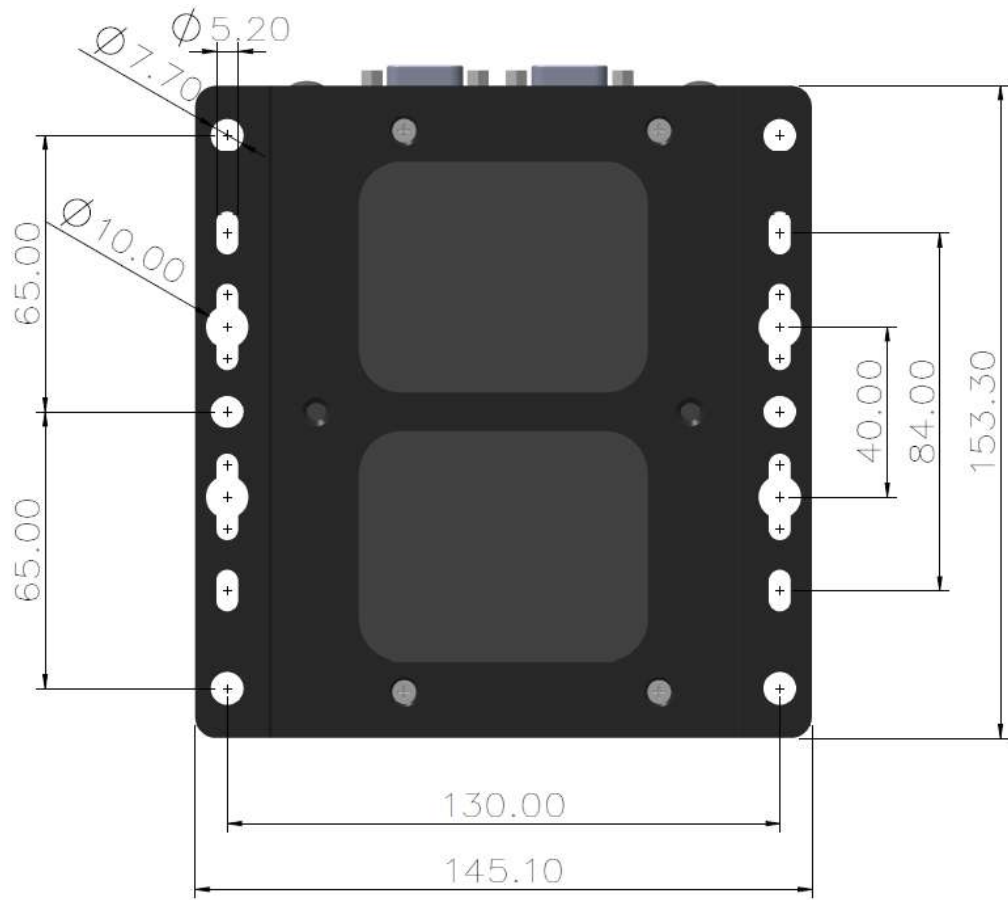

2 System Overview

Upon receiving and unpacking your POC-300 series, please check immediately if the package contains all the items listed in the following table. If any item(s) are missing or damaged, please contact your local dealer or Neosys Technology.

2.1 Unpacking the System

Item	Description	Qty
1	POC-300/ 310/ 320/ 330 ultra-compact fanless controller (Please verify additionally purchased accessories such as DDR3L module or mSATA SSD, etc.)	1
2	DVI-to-VGA adapter	1
3	3-pin pluggable terminal block	1
4	Neosys Drivers & Utilities DVD	1
5	DIN-Rail Mount Clip	1
6	Screw package	1

2.2 POC-300 Series Front Panel

The front panel of POC-300 systems feature rich I/O ports, it has three Gigabit Ethernet ports (two are 802.3at Gigabit PoE+ ports for POC-300 and POC-320), two USB3.0 ports, two USB2.0 ports, one DVI-I connector for VGA + DVI dual video output and 3-pin terminal block for DC input.

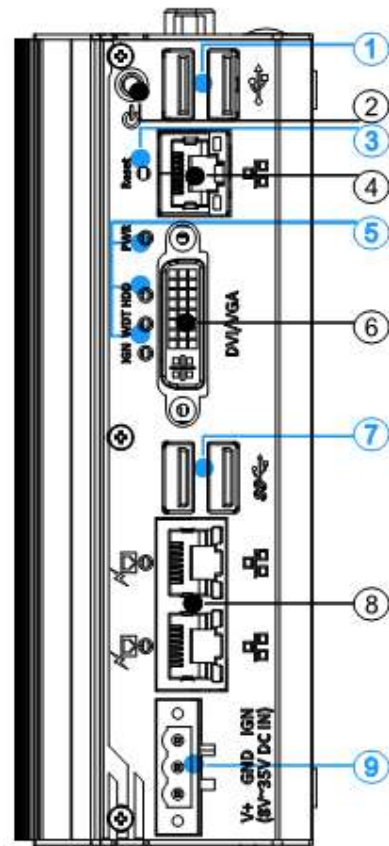

No.	Item	Description
1	USB 2.0 port	The USB 2.0 ports are backward compatible with USB 1.1 / 1.0.
2	Power button	Use this button to turn on or force shutdown the system.
3	Reset button	Use this button to manual restart the system.
4	Gigabit Ethernet #3	Gigabit Ethernet ports offer fast network access.
5	System status LED	Four system LEDs, Ignition control (IGN), Watchdog Timer (WDT), Hard Disk Drive (HDD) and Power (PWR).
6	DVI-I port	DVI-I offers both DVI and VGA signals. You can use the DVI-to-VGA adapter to connect a VGA display, or use Y-cable to have DVI/VGA dual display output. They support resolutions up to 1920 x 1200.
7	USB 3.0 port	USB 3.0 port, up to 5 Gbit/s data transfer bandwidth.
8	Gigabit PoE+ port #1 & #2	POC-300/ 320: Gigabit Power over Ethernet (PoE) port can provide both data and electric power to devices. POC-310/ 330: Standard Gigabit Ethernet ports offer fast network access.
9	3-pin terminal block (DC/ignition input)	Compatible with DC power input from 8~35V, the terminal block can also be used for ignition signal input.

2.2.1 USB 2.0 Port

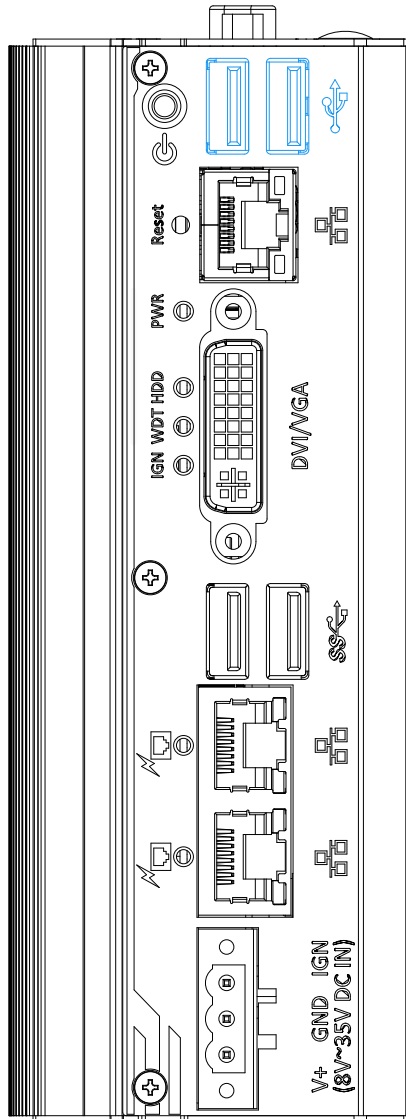

The USB2.0 ports are implemented via native xHCI (eXtensible Host Controller Interface) controller in Atom E3950/ Pentium N4200 SoC and are backward compatible with USB 1.1 and USB 1.0 devices. Legacy USB support is also provided so you can use USB keyboard/ mouse in DOS environment.

xHCI driver is supported natively in Windows 10, therefore you do not need to install xHCI driver to utilize USB functions on POC-300 series.

2.2.4 Gigabit Ethernet

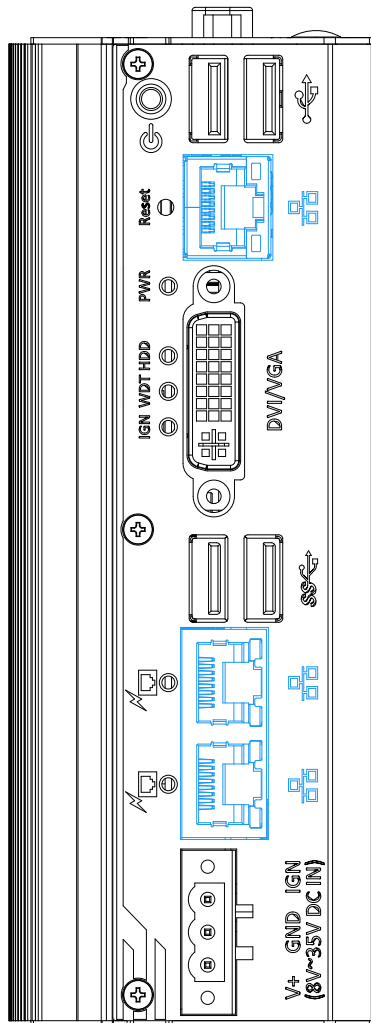

The system offers three Gigabit Ethernet ports using Intel® I210 GbE controller. From top to bottom, they are port #3, #1 and #2. When plugged in and connected via the Ethernet cable, the LEDs on the RJ45 connector indicate connection status and speed.

Active/Link LED (Right)

LED Color	Status	Description
Yellow	Off	Ethernet port is disconnected
	On	Ethernet port is connected and no data transmission
	Flashing	Ethernet port is connected and data is transmitting/receiving

Speed LED (Left)

LED Color	Status	Description
Green or Orange	Off	10 Mbps
	Green	100 Mbps
	Orange	1000 Mbps

2.2.5 System Status LED

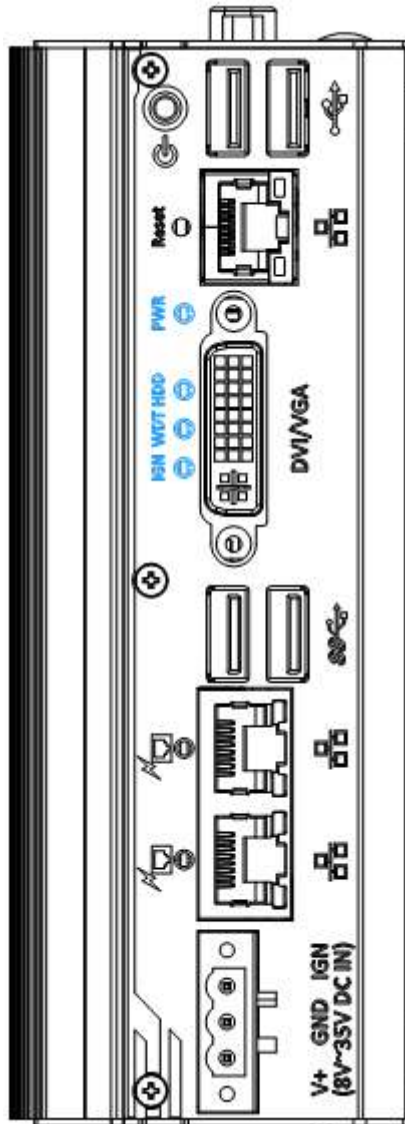

There are four LED indicators on the front panel: PWR, HDD, WDT and IGN. The descriptions of these four LEDs are listed in the following table.

Indicator	Color	Description
PWR	Green	Power indicator, lid when system is on
HDD	Red	Hard drive indicator, flashing when SATA HDD is active
WDT	Yellow	Watchdog timer indicator, flashing when watchdog timer has started
IGN	Green	If ignition option (MezIO-V20) is applied, this LED is used to indicate ignition signal status (lid when IGN signal is applied).

2.2.6 DVI-I Port

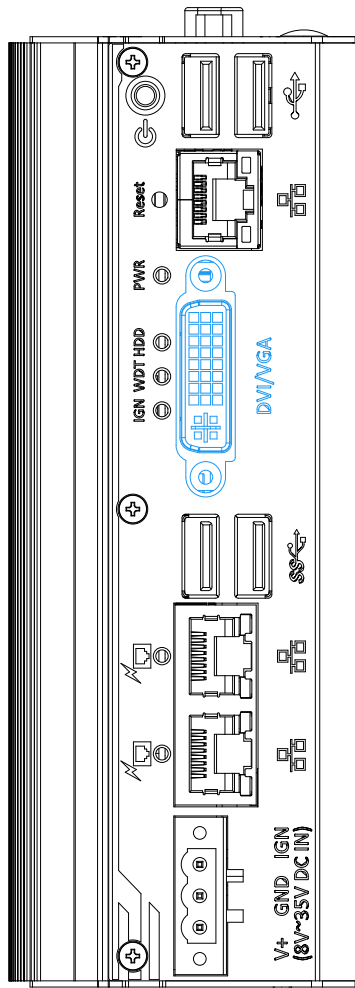

The system features a DVI-I connector on its front panel that is also compatible with VGA signals. The DVI and VGA outputs are directly driven by integrated Intel HD graphics engine and support up to 1920 x 1200 resolution.

For VGA monitor, Neusys offers a specialized DVI-to-VGA adapter as an accessory shipped with the system. This adapter supports VGA DDC signals and thus eliminates compatibility issues with VGA monitors. Or you can use a DVI-I to VGA+DVI-D Y-cable to support two independent display outputs



DVI to VGA adapter

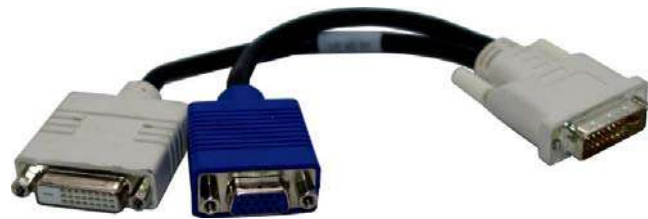

Optional DVI to VGA+DVI Y-cable

2.2.7 USB 3.0 Port

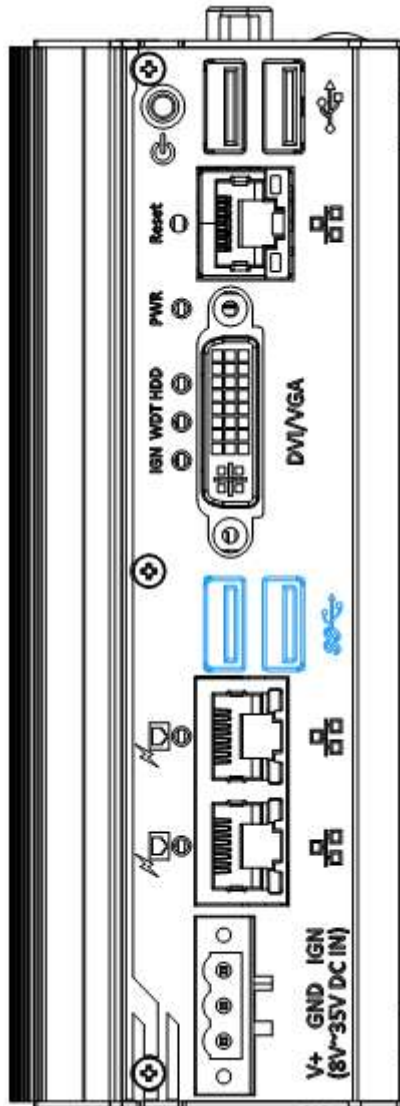

The system offers two USB 3.0 (SuperSpeed USB) ports on its front panel. They are implemented by native xHCI (eXtensible Host Controller Interface) controller in Atom E3950/ Pentium N4200 SoC and are backward compatible with USB 2.0, USB 1.1 and USB 1.0 devices. Legacy USB support is also provided so you can use USB keyboard/mouse in DOS environment

xHCI driver is supported natively in Windows 10, therefore you do not need to install xHCI driver in prior to utilize USB function on POC-300 series.

2.2.8 IEEE 802.3at Power over Ethernet Port #1 & #2 (POC-300/ POC-320 Only)

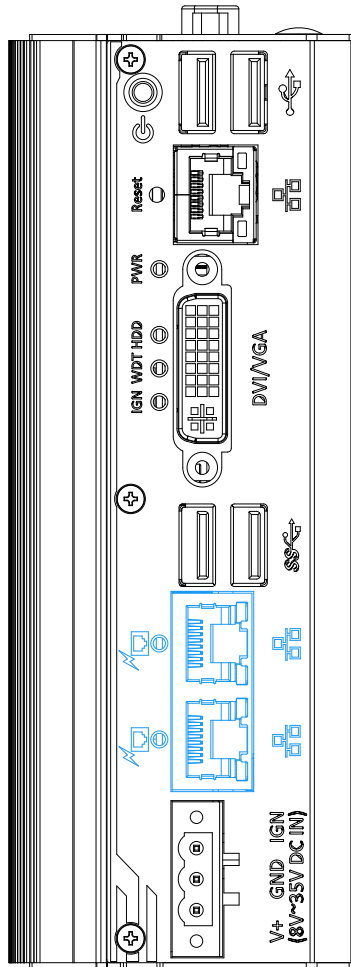

The Power over Ethernet (PoE) port supply power and data on a standard CAT-5/CAT-6 Ethernet cable. Acting as a PSE (Power Sourcing Equipment), compliant with IEEE 802.3at, each port delivers up to 25W to a Powered Device (PD). PoE automatically detects and determine if the connected device is PoE PD or not before supplying power, making it compatible with standard Ethernet devices as well.

Active/Link LED (Right)

LED Color	Status	Description
Yellow	Off	Ethernet port is disconnected
	On	Ethernet port is connected and no data transmission
	Flashing	Ethernet port is connected and data is transmitting/receiving

Speed LED (Left)

LED Color	Status	Description
Green or Orange	Off	10 Mbps
	Green	100 Mbps
	Orange	1000 Mbps

2.2.9 3-Pin Terminal Block for DC Input/ Ignition Input

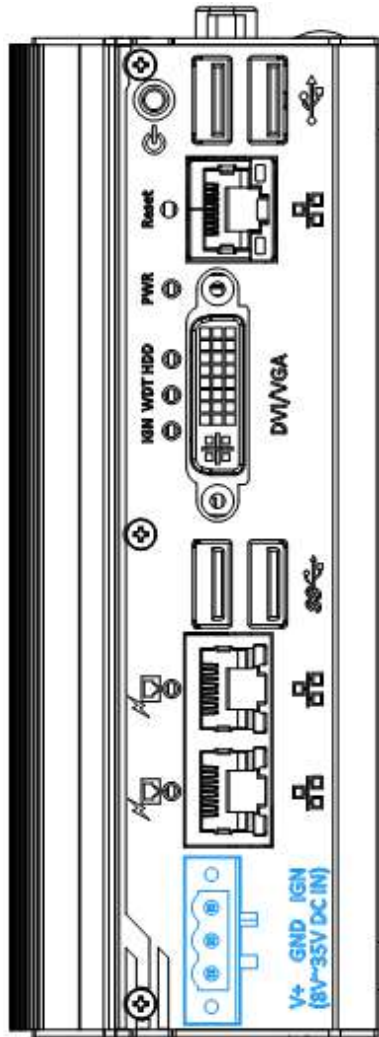

The system accepts a wide range of DC power input from 8 to 35V via a 3-pin pluggable terminal block, which is fit for field usage where DC power is usually provided. The screw clamping mechanism on the terminal block offers connection reliability when wiring DC power.

In addition to DC power input, this terminal block can also accept ignition signal input (IGN) when ignition control module (eg. MezIO-V20) is installed for in-vehicle applications.





WARNING

Please make sure the voltage of DC power is correct before you connect it to the system. Supplying a voltage over 35V will damage the system.

2.3 POC-300 Series Top Panel

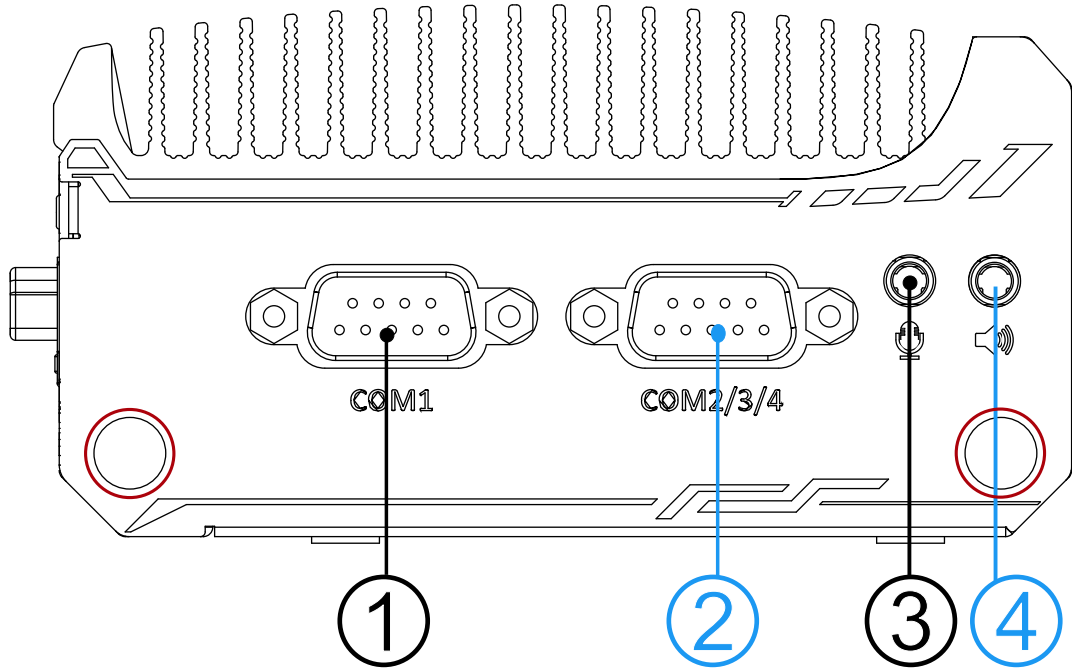
The top panel of POC-300 series features additional I/O functions, such as 3.5mm speaker-out/ microphone-in jacks, COM ports implemented using ITE8786 SIO chip, and antenna holes for antenna installation.



No.	Item	Description
1	COM port 1	Software programmable RS-232/ 422/ 485 port
2	COM port 2/ 3/ 4	Can be configured as: COM2: single RS-422/ 485 port COM2/ COM3/ COM4: three 3-wire RS-232 ports
3	Microphone-in	3.5mm microphone-in jack for voice input.
4	Speaker-out	3.5mm speaker-out/ microphone-out jack for sound output
5		Opening reserved for SMA antenna installation

2.3.1 COM Port (COM1)

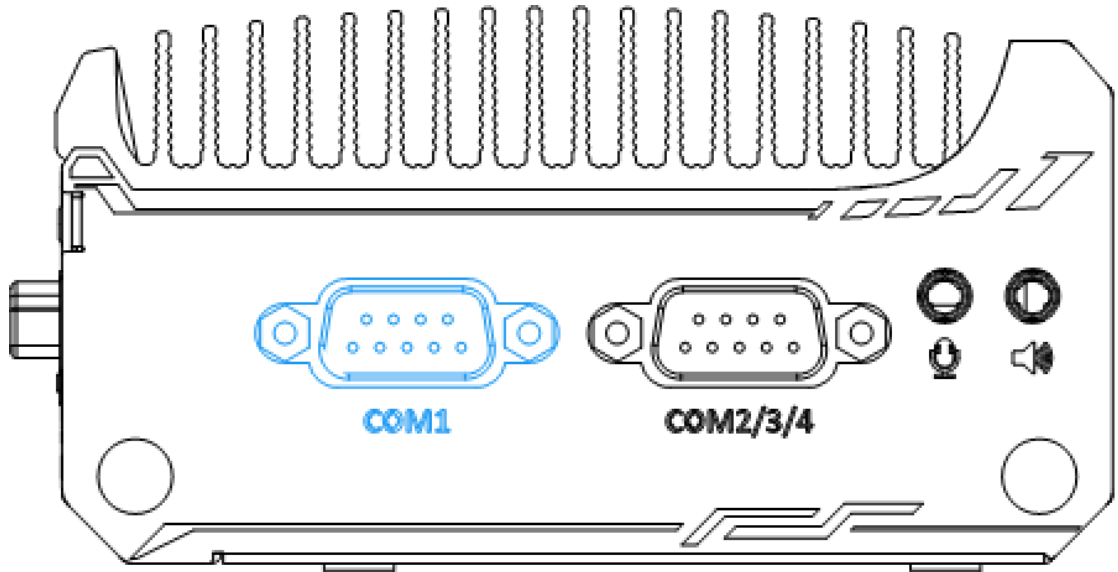

Implemented using industrial-grade ITE8786 Super IO chip (-40 to 85°C) and provide up to 921600 bps baud rate, COM1 is a software-configurable RS-232/422/485 port via 9-pin D-Sub male connector. The operation mode, slew rate and termination of COM1 can be set in BIOS setup utility. The following table describes the pin definition of COM ports.

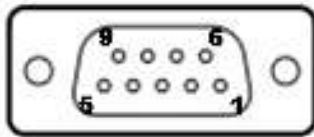

Pin#	COM1		
	RS-232 Mode	RS-422 Mode	RS-485 Mode (Two-wire 485)
1	DCD		
2	RX	422 TXD+	485 TXD+/RXD+
3	TX	422 RXD+	
4	DTR	422 RXD-	
5	GND	GND	GND
6	DSR		
7	RTS		
8	CTS	422 TXD-	485 TXD-/RXD-
9	RI		

2.3.2 COM Ports (COM2/ COM3/ COM4)

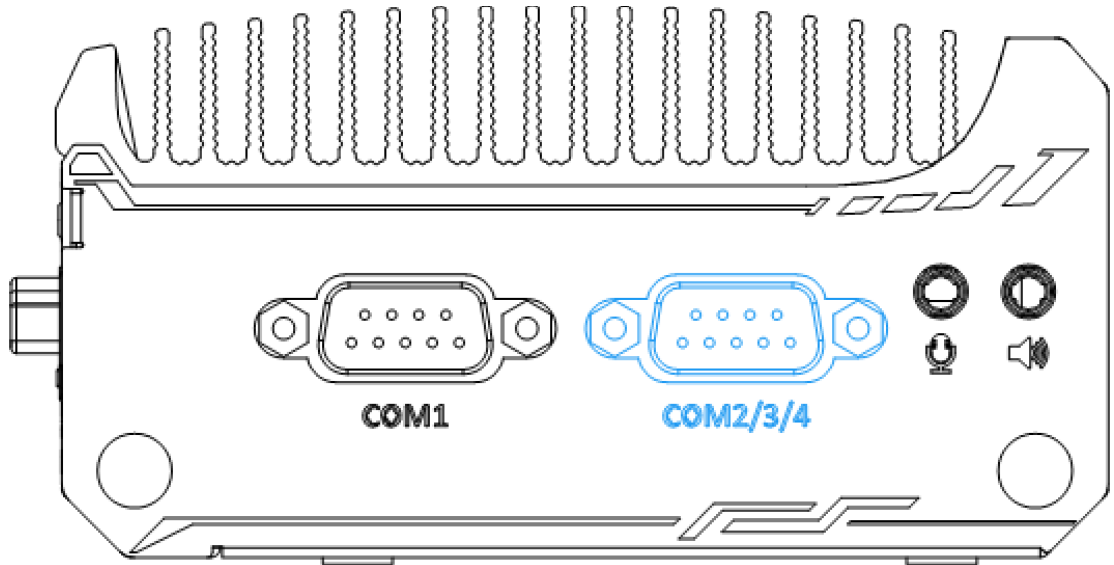

Implemented using industrial-grade ITE8786 Super IO chip (-40 to 85°C) and provide up to 921600 bps baud rate, the second D-Sub male connector (COM2/ 3/ 4) can be configured in BIOS as single RS-422/ 485 port (COM2) or three 3-wire RS-232 ports (COM2/COM3/COM4). Please refer to [COM2/ 3/ 4 Port Configuration](#) for configuring operation mode. An optional 1-to-3 Y-cable is available to connect three RS-232 devices.

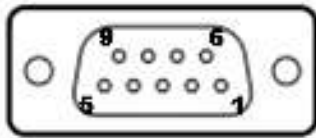

COM2/ 3/ 4 Pin



1-to-3 Y-cable



The following table describes the pin definition of the COM port

	3-port RS-232 COM2/ 3/ 4		
Pin#	COM2	COM3	COM4
1			
2	RX		
3	TX		
4		TX	
5	GND	GND	GND
6		RX	
7			TX
8			RX
9			

	Single port RS-422/ 485	
Pin#	RS-422	RS-485
1		
2	TxD+	TxD+/ RxD+
3	RxD+	
4	RxD-	
5	GND	GND
6		
7		
8	TxD-	TxD-/ RxD-
9		

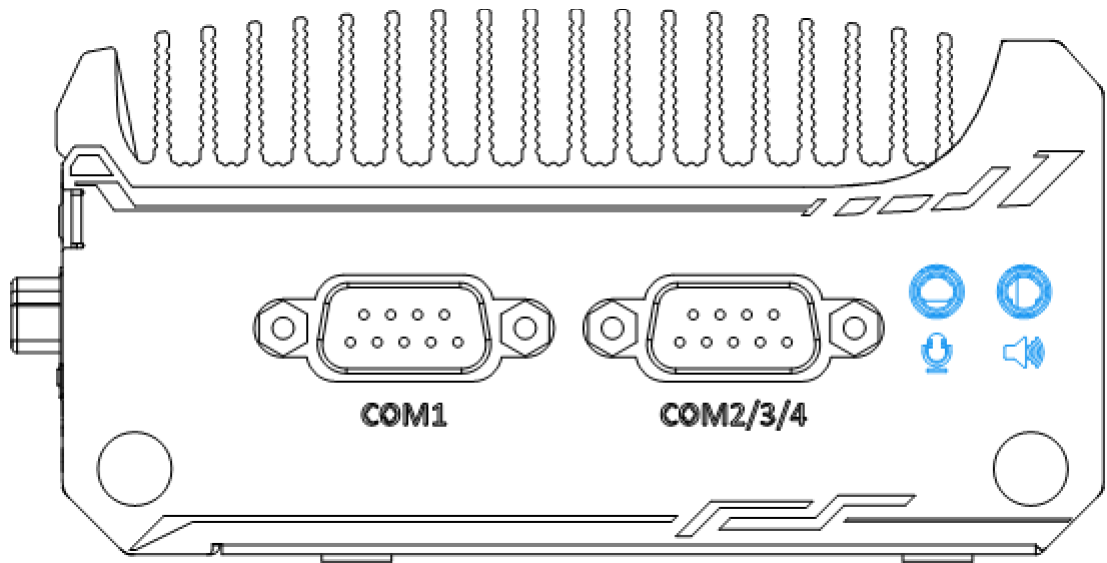
2.3.3 3.5mm Microphone-in/ Speaker-out Jack



The system provides audio function using Intel® High Definition Audio in Atom E3950/ Pentium N4200 SoC and Realtek ALC262 codec. There are two audio jacks on the top panel. The  port is used for microphone input, and  port is used for speaker output. To utilize the audio function in Windows, you need to install corresponding drivers for both Intel® HD audio and Realtek ALC262 codec. Please refer to the section, [Driver Installation](#).

2.3.4 SMA Antennae Opening

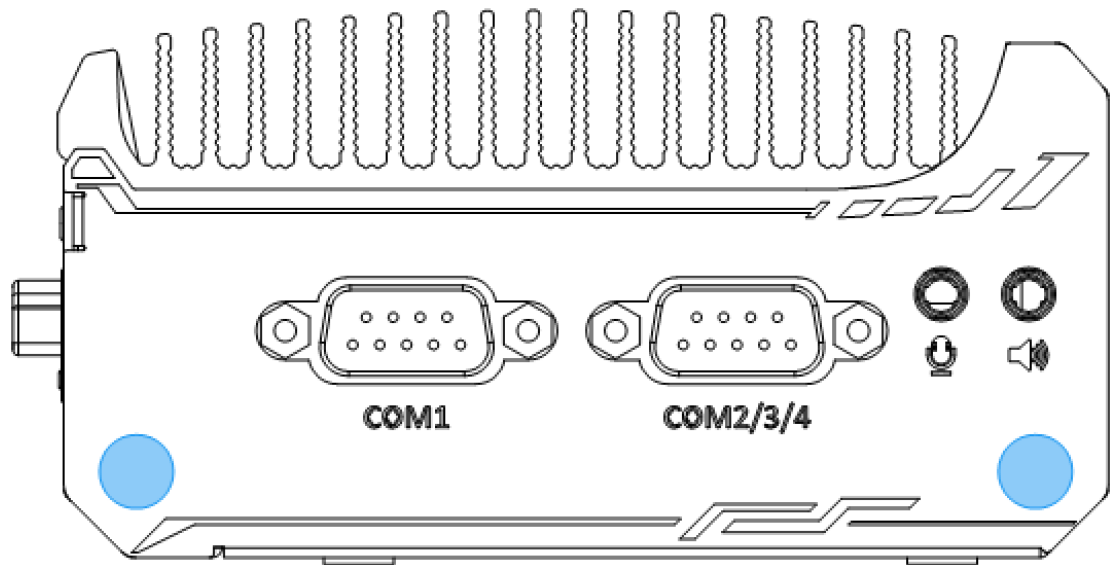

The system offers two SMA antenna openings reserved for SMA antenna installations. Users can take advantage of these two openings when installing mini-PCIe module for wireless communication reception such as 3G, 4G, GPS or WiFi.

2.4 POC-300 Series Internal I/O

The system's internal I/O connectors consist of a SO-DIMM socket, mini-PCIe slot with USIM slot, a half-size mSATA port and a MezIO™ port for application-oriented expansion purposes.

2.4.1 DDR3L SO-DIMM Socket

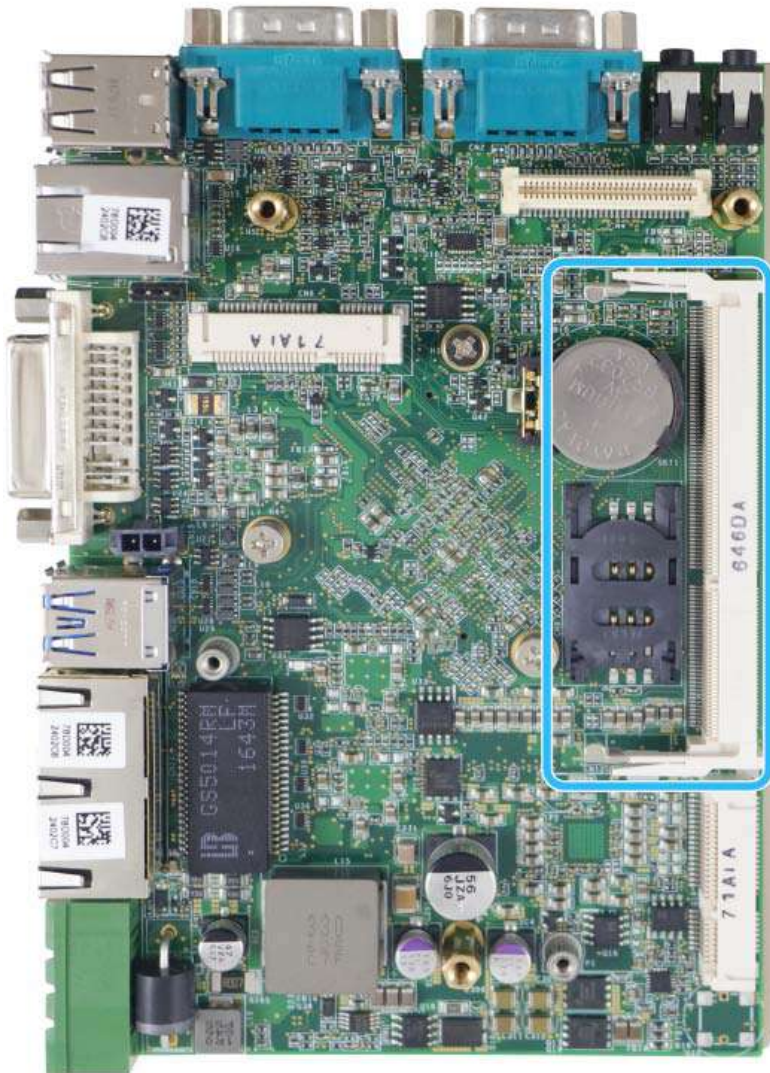

The system has an internal SO-DIMM slot supporting DDR3L-1866 memory module up to 8GB in capacity. The L in DDR3"L"-1866 denotes Low Voltage (1.35V) type SO-DIMM memory modules.

2.4.2 Full-size mini-PCle Socket

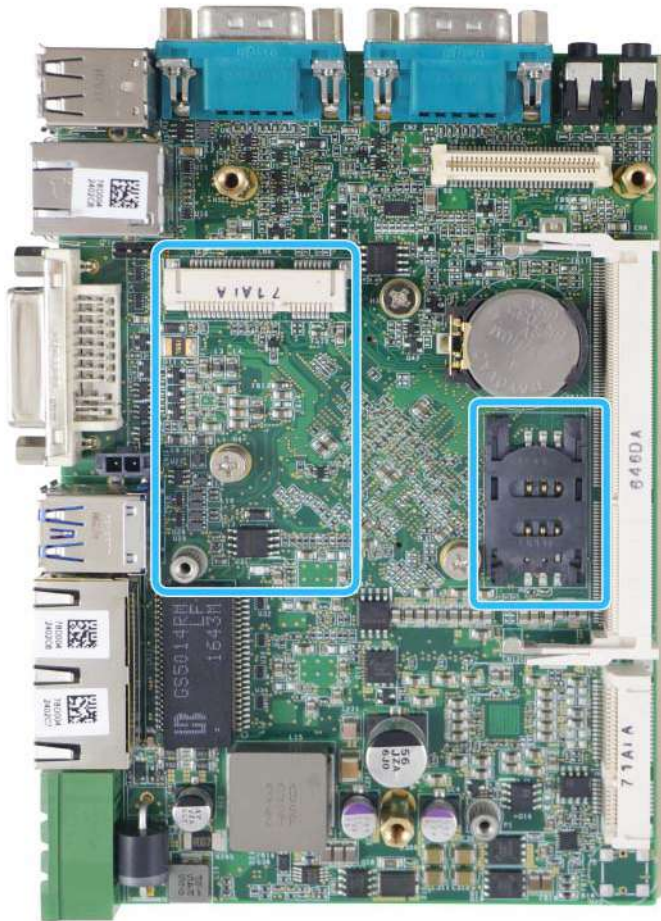

The system provides a full-size mini-PCle socket that is in compliance with mini-PCle specification rev. 1.2. The mini-PCle socket is designed with SIM card support. With a SIM card installed, your system can access the internet via your network provider's 3G/ 4G network.

For wireless (WIFI/ 3G/ 4G) communication, there are two SMA antenna openings at the top of the system.



NOTE

When MezIO-D230/230 module is installed, the mini-PCle socket is not available due to mechanical interference.

mini-PCle Pin Definition

Pin #	Signal	Pin #	Signal
1	WAKE#	2	+3.3Vaux
3	COEX1	4	GND
5	COEX2	6	+1.5V
7	CLKREQ#	8	UIM_PWR
9	GND	10	UIM_DATA
11	REFCLK-	12	UIM_CLK
13	REFCLK+	14	UIM_RESET
15	GND	16	UIM_VPP
Mechanical Key			
17	Reserved* (UIM_C8)	18	GND
19	Reserved* (UIM_C4)	20	W_DISABLE#
21	GND	22	PERST#
23	PERn0	24	+3.3Vaux
25	PERp0	26	GND
27	GND	28	+1.5V
29	GND	30	SMB_CLK
31	PETn0	32	SMB_DATA
33	PETp0	34	GND
35	GND	36	USB_D-
37	GND	38	USB_D+
39	+3.3Vaux	40	GND
41	+3.3Vaux	42	LED_WWAN#
43	GND	44	LED_WLAN#
45	Reserved	46	LED_WPAN#
47	Reserved	48	+1.5V
49	Reserved	50	GND
51	Reserved	52	+3.3Vaux



WARNING

Some off-the-shelf mini-PCle 4G modules use 1.8V I/O signals instead of 3.3V I/O and may cause signal interference. Installing an incompatible 4G module may damage the system or the module itself may be damaged. Please consult with Neousys when in doubt!

2.4.3 Half-size mSATA Socket

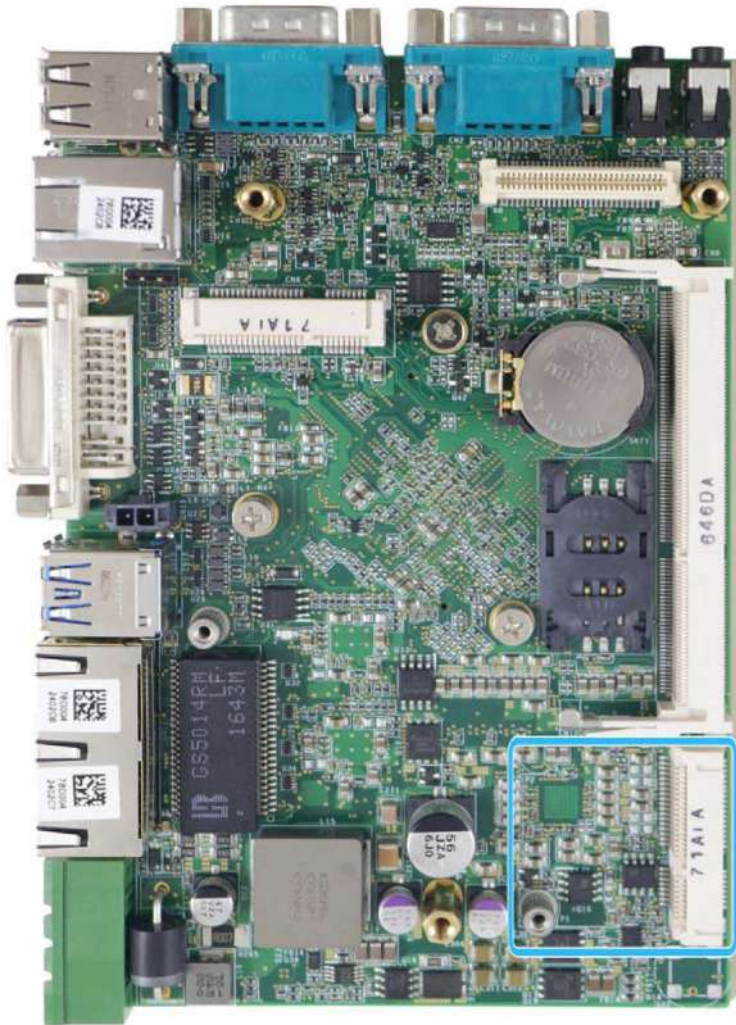

The system features one half-size mSATA socket. You can install a half-size mSATA SSD for operating system installation. The half-size mSATA SSD has all the advantages of solid state disk technology such as lower power consumption and is higher shock/ vibration resistant over traditional hard disk drives.

Half-Size mSATA Socket Pin Definition

Pin #	Signal	Pin #	Signal
1	-	2	+3.3Vaux
3	-	4	GND
5	-	6	+1.5V
7	-	8	-
9	GND	10	-
11	-	12	-
13	-	14	-
15	GND	16	-
Mechanical Key			
17	-	18	GND
19	-	20	-
21	GND	22	-
23	SATA_Rxp	24	+3.3Vaux
25	SATA_Rxn	26	GND
27	GND	28	+1.5V
29	GND	30	SMB_CLK
31	SATA_Txn	32	SMB_DATA
33	SATA_Txp	34	GND
35	GND	36	-
37	GND	38	-
39	+3.3Vaux	40	GND
41	+3.3Vaux	42	-
43	-	44	-
45	-	46	-
47	-	48	+1.5V
49	-	50	GND
51	-	52	+3.3Vaux

2.5 MezIO™ Interface

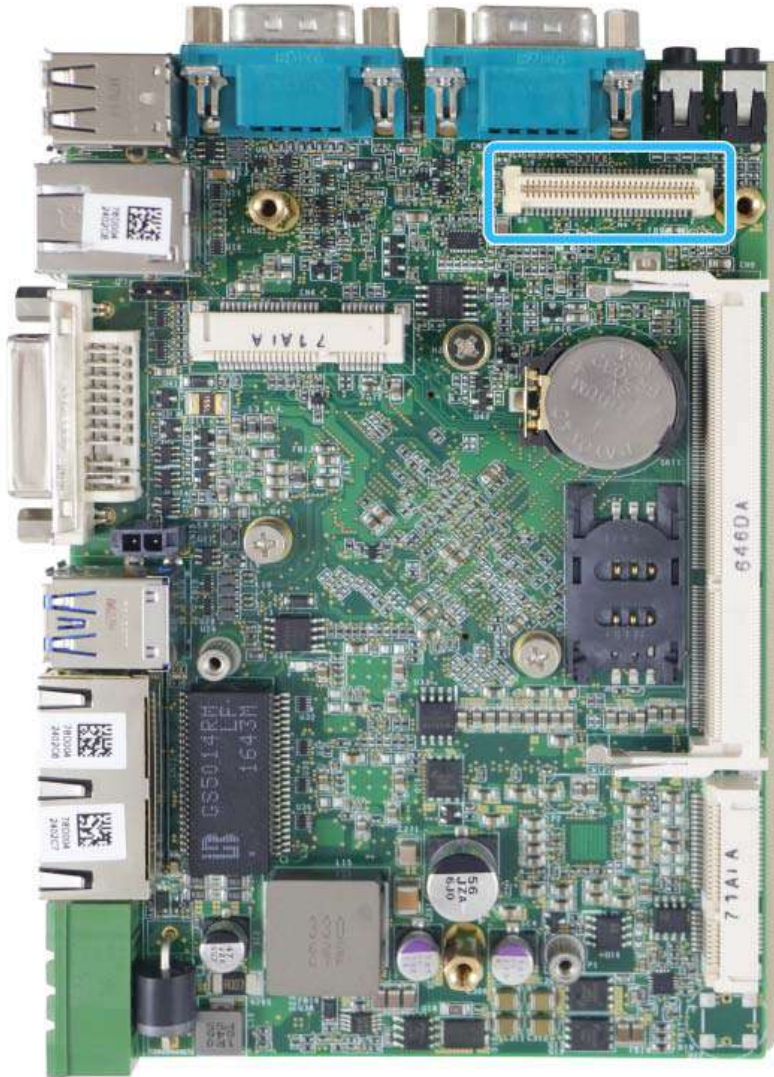

MezIO™ is an innovative interface designed for integrating application-oriented I/O functions into an embedded system. It offers computer signals, power rails and control signals via a high-speed connector. MezIO™ is also mechanically reliable benefited from its 3-point mounted mezzanine structure. A MezIO™ module can leverage these signals to implement comprehensive I/O functions.

POC-300 series incorporates MezIO™ interface and universal mechanical design to accommodate Neusys' standard MezIO™ modules. For customers who want to develop their own MezIO™ module, Neusys provides MezIO™ design documents on a NDA basis. Please contact Neusys for further information.

2.5.1 MezIO™ Interface Pin Definition



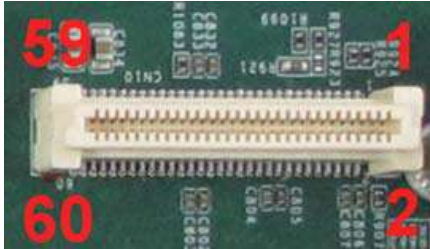



MezIO™ interface leverages FCI BERGSTAK® board-to-board connector to provide interconnectivity of high-speed signals. The receptacle part on the PCBA is FCI 61082-063402LF while the plug part on the MezIO™ module is FCI 61083-064402LF. Please refer to the following table for signal definition of its 60-pos connector.



Function Description	Signal	Pin#	Pin#	Signal	Function Description
Reserved	Reserved	1	2	PCIE TXP 0	PCIe data pair
Reserved	Reserved	3	4	PCIE TXN 0	PCIe data pair
Reserved	Reserved	5	6	GND	Ground
Reserved	Reserved	7	8	PCIE RXP 0	PCIe data pair
System S4 signal	SLP S4#	9	10	PCIE RXN 0	PCIe data pair
Ground	GND	11	12	CLK100 P 0	PCIe clock pair
Reserved	Reserved	13	14	CLK100 N 0	PCIe clock pair
Ground	GND	15	16	GND	Ground
Reserved	UID LED	17	18	PCIE TXP 1	PCIe data pair
Platform reset	PLT RST#	19	20	PCIE TXN 1	PCIe data pair
USB data pair	USBP5 N	21	22	PCIE RXP 1	PCIe data pair
USB data pair	USBP5 P	23	24	PCIE RXN 1	PCIe data pair
Ground	GND	25	26	GND	Ground
SMB bus	SMB DATA	27	28	CLK100 P 1	PCIe clock pair
SMB bus	SMB CLK	29	30	CLK100 N 1	PCIe clock pair
N/C	N/C	31	32	GND	Ground
N/C	N/C	33	34	N/C	N/C
Ground	GND	35	36	N/C	N/C
N/C	N/C	37	38	GND	Ground
N/C	N/C	39	40	N/C	N/C
Power button	PWRBTN#	41	42	N/C	N/C
Reserved	Reserved	43	44	RXD4	SIO COM4
PCH GPIO	GPIO RISE	45	46	TXD4	SIO COM4
PCH GPIO	GPIO RISE	47	48	RXD5	SIO COM5
PCH GPIO	GPIO RISE	49	50	TXD5	SIO COM5
Ground	GND	51	52	GND	Ground
3.3V power	P3V3	53	54	P1V8	1.8V power
3.3V power	P3V3	55	56	GND	Ground
5V power	P5V	57	58	P12V	12V power
5V power	P5V	59	60	P12V	12V power

2.5.2 MezIO™ Modules for POC-300 Series

Neosys offers MezIO™ modules to expand I/O functions for Neosys systems. With the addition of a MezIO™ module into your system, it offers extra RS-232/ 422/ 485 ports, isolated digital I/ O, 2.5" HDD/ SSD accommodation or ignition power control.

Model	Description	Product Photo
MezIO-R11	SATA port	
MezIO-R12	SATA port + 4x isolated DI/ 4x isolated DO	
MezIO-C180-50	4-port RS-232/422/485 + 4-port RS-232	
MezIO-C181-50	4-port RS-232/422/485 + 4-port RS-422/485	
MezIO-D220-50*	8-CH isolated DI + 8-CH isolated DO	
MezIO-D230-50*	16-CH isolated DI + 16-CH isolated DO	
MezIO-V20	16-mode ignition power control	

*When a MezIO-D230 or MezIO-D220 module is installed, the mini PCIe slot can not be used due to mechanical interference.

3 System Installation

Before disassembling the system enclosure and installing components and modules, please make sure you have done the following:

- It is recommended that only qualified service personnel should install and service this product to avoid injury or damage to the system.
- Please observe all ESD procedures at all times to avoid damaging the equipment.
- Before disassembling your system, please make sure the system has powered off, all cables and antennae (power, video, data, etc.) are disconnected.
- Place the system on a flat and sturdy surface (remove from mounts or out of server cabinets) before proceeding with the installation/ replacement procedure.

3.1 Disassembling the System Enclosure

To install necessary components such as DDR3L memory, mSATA and/ or MeziO™ module, you need to disassemble the POC-300 system enclosure:

1. To disassemble POC-300, unfasten the three (3) screws shown in the illustration A and the two (2) screws shown in illustration B, below.



Illustration A



Illustration B

2. Gently slide the L-shaped enclosure open to gain access to internal I/O connectors.



3.2 Installing Internal Components

3.2.1 DDR3L SO-DIMM Installation

There is one SO-DIMM memory slot on POC-300 series motherboard. Please follow the procedures below to install the memory module.

1. [Disassemble the system enclosure](#)
2. The SO-DIMM slot can be located once the enclosure has been removed.

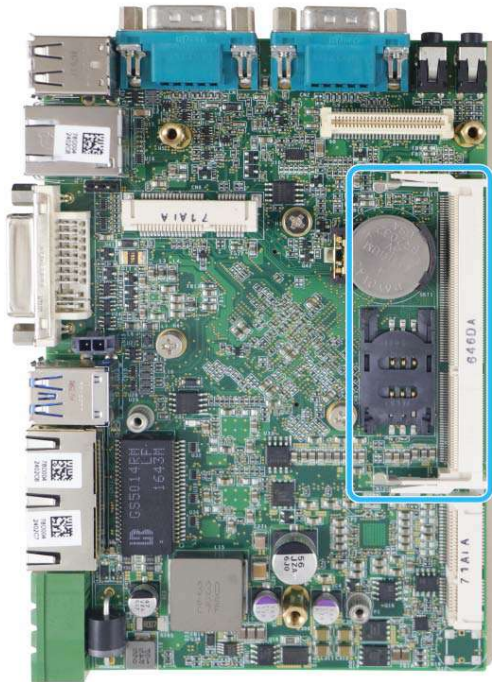

3. **To install**, insert the gold finger end of the SO-DIMM on a 45 degree angle into the slot and gently push the SO-DIMM down until it clips-in.



3.2.2 mini-PCIe Module, SIM Card and Antennae Installation

There is one mini-PCIe with USIM expansion slot on POC-300 series motherboard. Please follow the procedures below to install the mini-PCIe module and SIM card, as well as the antenna for wireless communication.

1. [Disassemble the system enclosure.](#)
2. The mini-PCIe and USIM slot can be located once the enclosure has been removed.

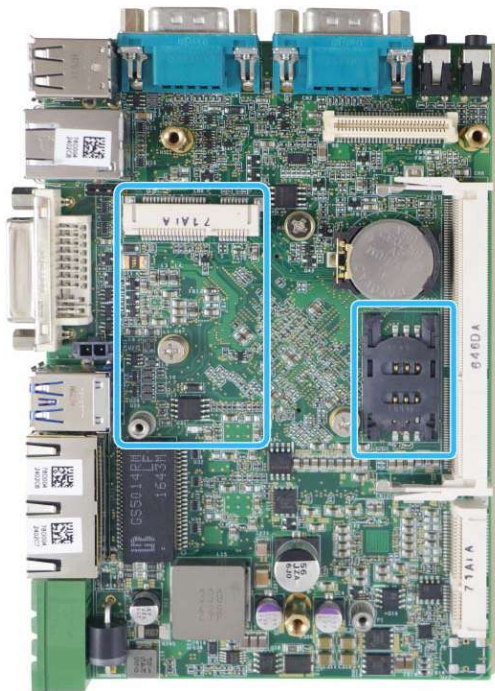

3. **To install**, insert mini-PCIe module's gold finger on a 45 degree angle into the socket, gently press the module down and secure it with a screw.



- The SIM card slot utilizes a slide-and-clamp mechanism. To open the slot, slide the top section away from the battery and flip open the slot.

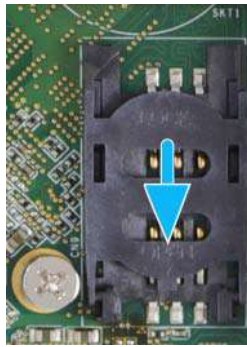

Push away from the battery



Flip open the slot

- Insert the SIM card into the flipped open section, close, gently press and slide the top section towards the battery to secure the SIM card in place.



Insert the SIM card



Secure the SIM card

- Clip-on mini-PCIe module's antennae (please refer to the module's user manual on antennae cable connection).



- Remove the Antennae cover from the enclosure.
- Please refer to the illustration below to secure the SMA antennae.

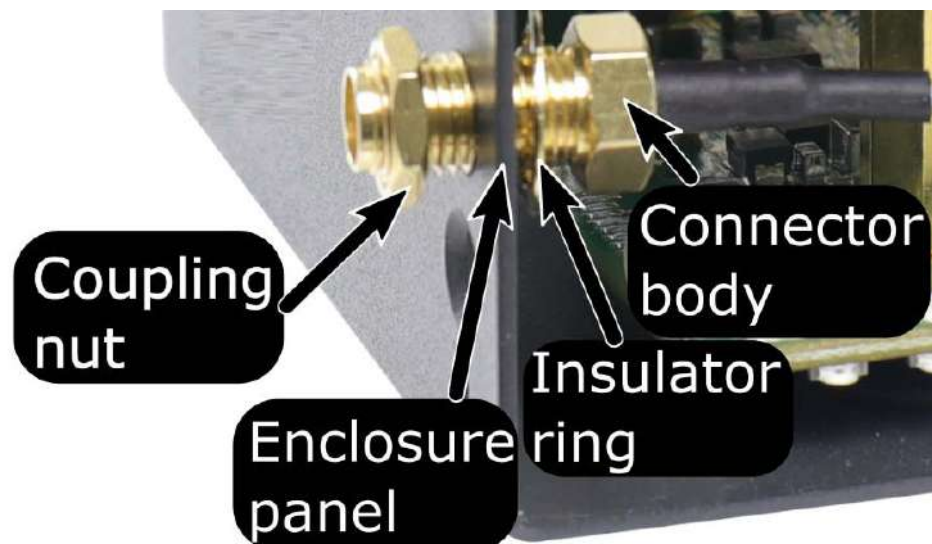

9. [Reinstall the system enclosure](#) and attach the external antennae to complete the installation.



3.2.3 mSATA Module Installation

There is one half-size mSATA expansion slot on POC-300 series motherboard. Please follow the procedures below to install the half-size mSATA module.

1. [Disassemble the system enclosure.](#)
2. The half-size mSATA slot can be located once the enclosure has been removed.



3. Insert the half-size mSATA module on a 45 degree angle.



4. Gently press the card down and secure with a screw.



5. [Reinstall the system enclosure.](#)

3.2.4 2.5" HDD/ SSD Installation (for MezIO-R11/ R12)

MezIO-R11/ R12 offer a SATA port for users to install a 2.5" HDD/ SSD in their POC-300 series systems. A MezIO-R12 will be used as an example in the following procedure to demonstrate installation.

1. On your MezIO module, location the SATA port (indicated in **blue**) and the four support stands (indicated in **red**).

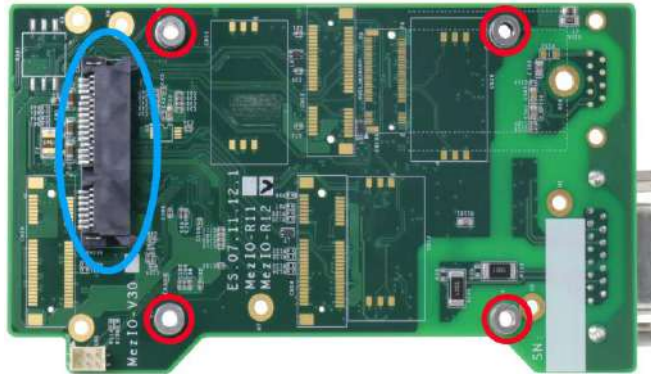

2. Match the 2.5" HDD/ SSD SATA connector to the SATA port on the module and gently insert the HDD/ SSD into place.



3. Secure the 2.5" HDD/ SSD with the supplied four flathead screws. The screws are inserted (indicated in **red**) from the same side as the MezIO connector (indicated in **blue**).

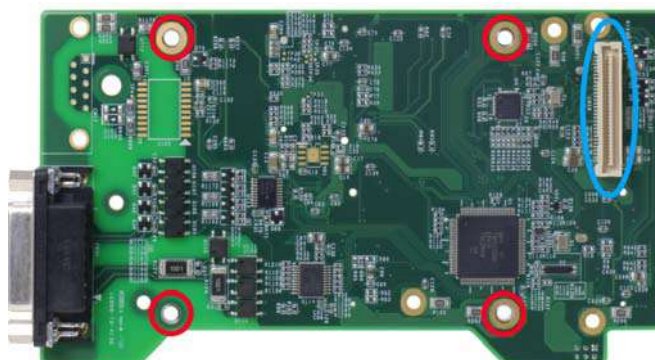

4. Once the 2.5" HDD/ SSD is secured, the module is ready to be installed into the system. Please refer to the section, [MezIO™ Module Installation](#) for details.

3.2.5 MezIO™ Module Installation

The system comes with a MezIO™ module expansion slot. For specific MezIO™ module I/O functionalities, please refer to the [MezIO™ Module](#) section. For installation, please refer to the following procedure.

1. [Disassemble the system enclosure.](#)
2. The MezIO™ module expansion slot can be located once the enclosure has been removed.



3. The stand-off hex bolts are shipped with MezIO module. POC-300 comes with M3, P-head screws. Here we need to remove P-head screws and replace them with stand-off bolts



4. To install, match the three (3) screw holes (indicated by black arrows) to the standoffs and the MezIO™ port, gently lower the module onto the PCBA. The MezIO™ port should engage if the three (3) standoffs and screw holes meet. Then using the three (3) screws supplied, secure the module by fastening a screw on each standoff.

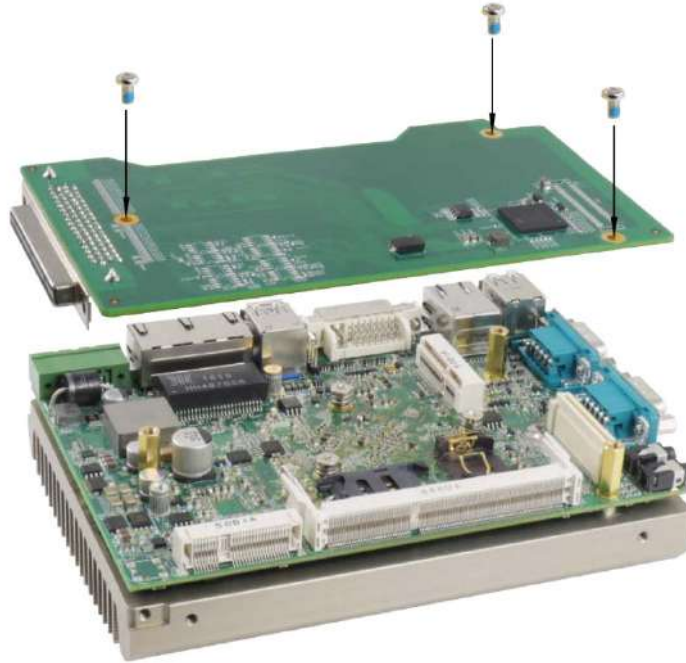

5. If you are installing a new MezIO™ module into your system, you'll need to remove the I/O shield opening for the connector.



6. [Reinstall the system enclosure.](#)

3.3 Installing the System Enclosure

1. To reinstall the system enclosure, gently slide the L-shaped enclosure back in place making sure the screw hole on the hinge sits on the inside.



Place enclosure back in-place

Make sure hinge sits on the inside

2. Complete installing the system enclosure by fastening five (5) screws.



3.4 DIN Rail Installation

The DIN rail is easy to install and it is a convenient way to position the system. The Din rail has been proven to be most beneficial in the industrial environment where space is limited. The mount plate comes with two M4 screws. Please refer to the illustrations below to install the DIN clip/ rail.

1. To install, secure the DIN rail clip onto the rear of the system enclosure using the M4 screws provided.

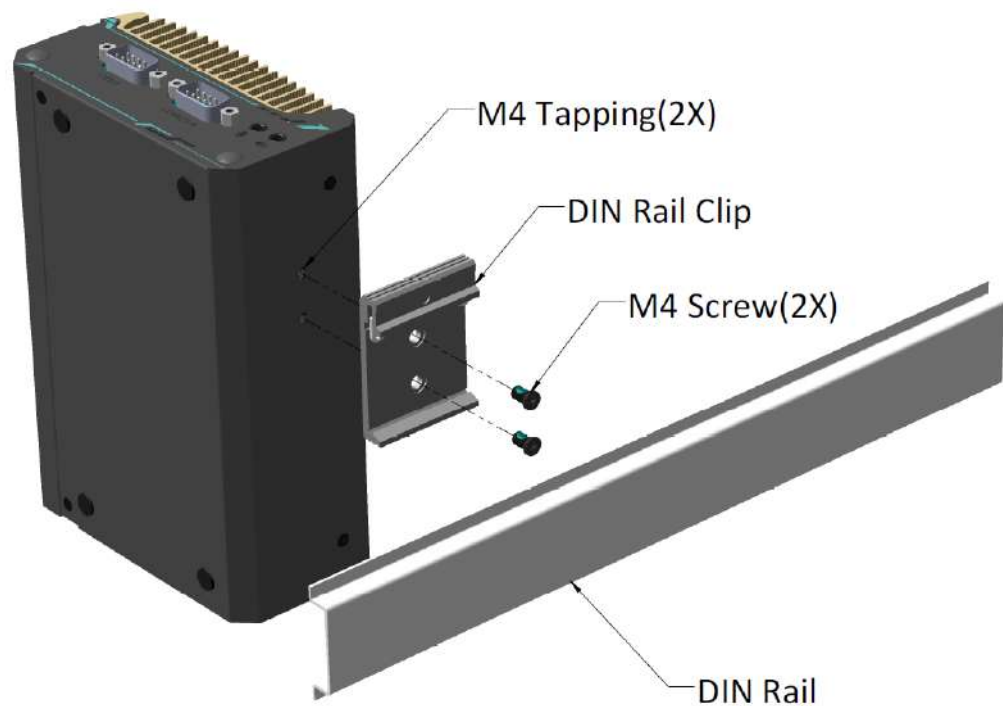

2. To install the mount plate onto the DIN rail, you must come over the top of the DIN rail, tilting downwards, overlap the top clip edge of the mount plate onto the DIN rail first, then firmly press the bottom-front of the enclosure to clip the bottom edge of the mount plate.

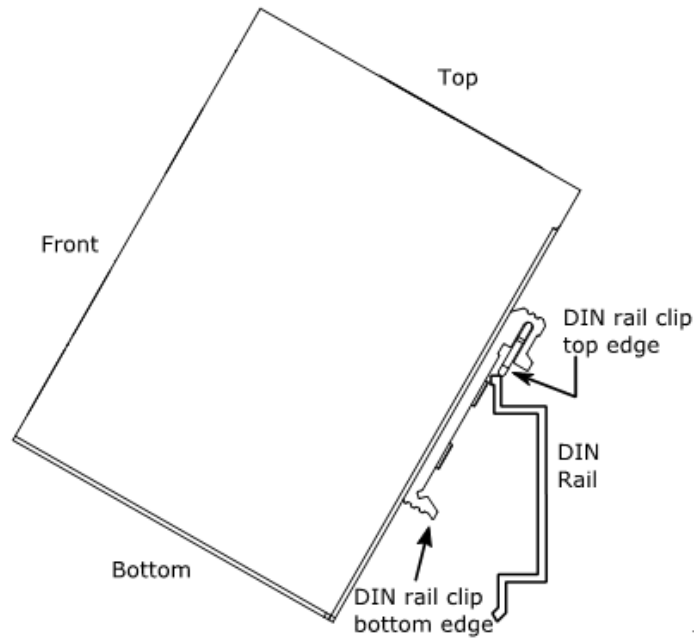

3. Confirm the mount plate has indeed clipped onto the DIN rail for proper fit to complete the installation.

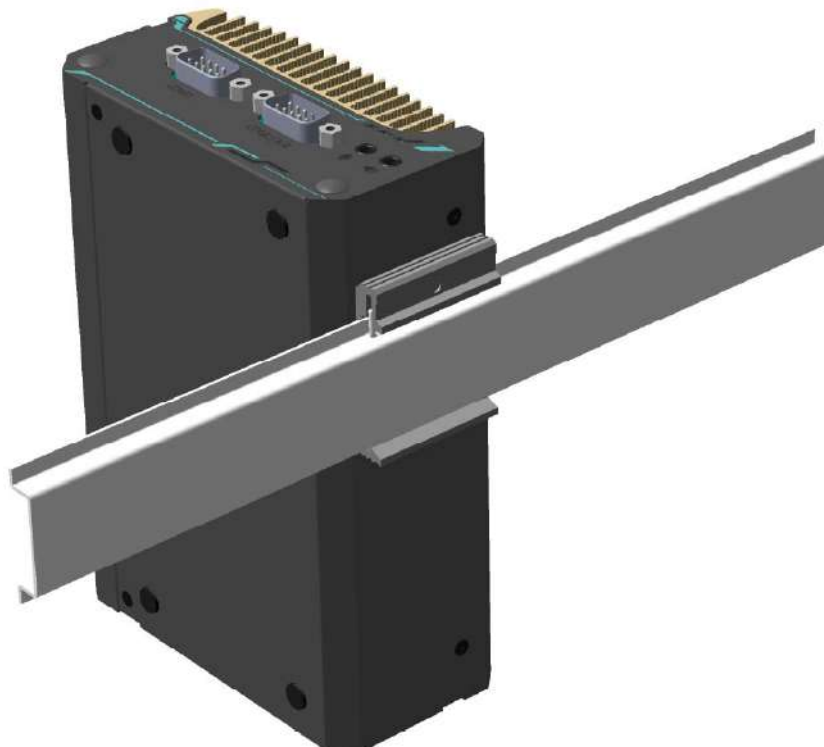

3.5 Wall Mount Bracket Installation (with WM-300V)

1. To install the full size wall mount bracket, locate a flat surface area (wall, ceiling, etc.) free from obstructions that meets the following dimensions.

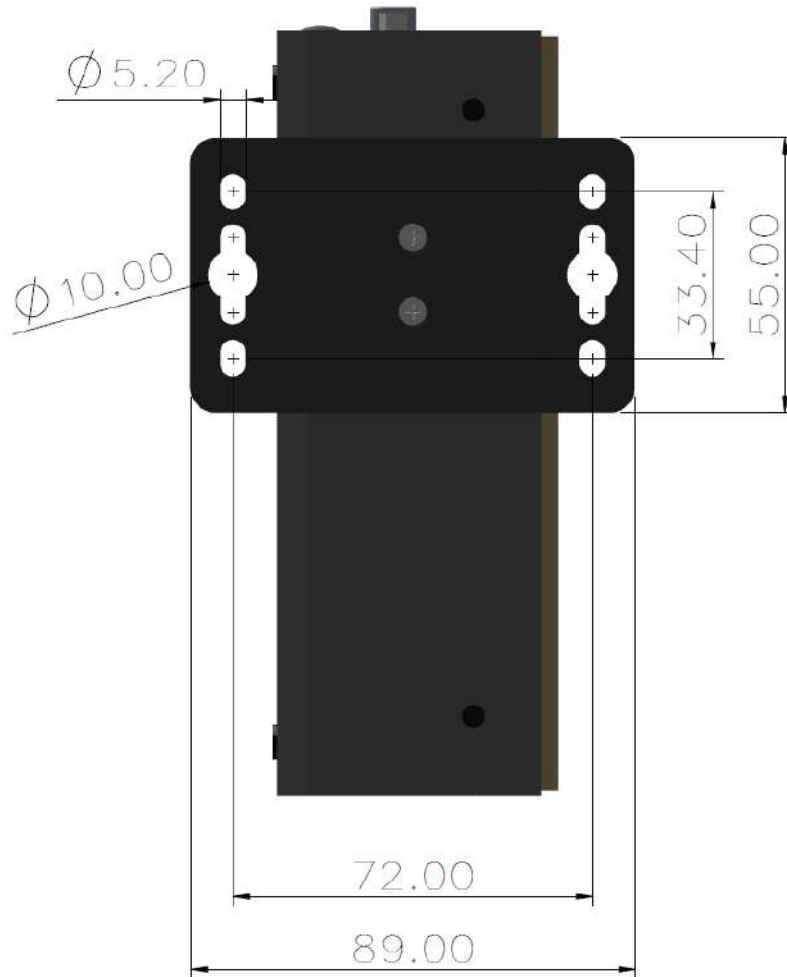

2. To install, simply secure WM-300V wall mount bracket with the four M4 screws supplied onto the enclosure shown below.

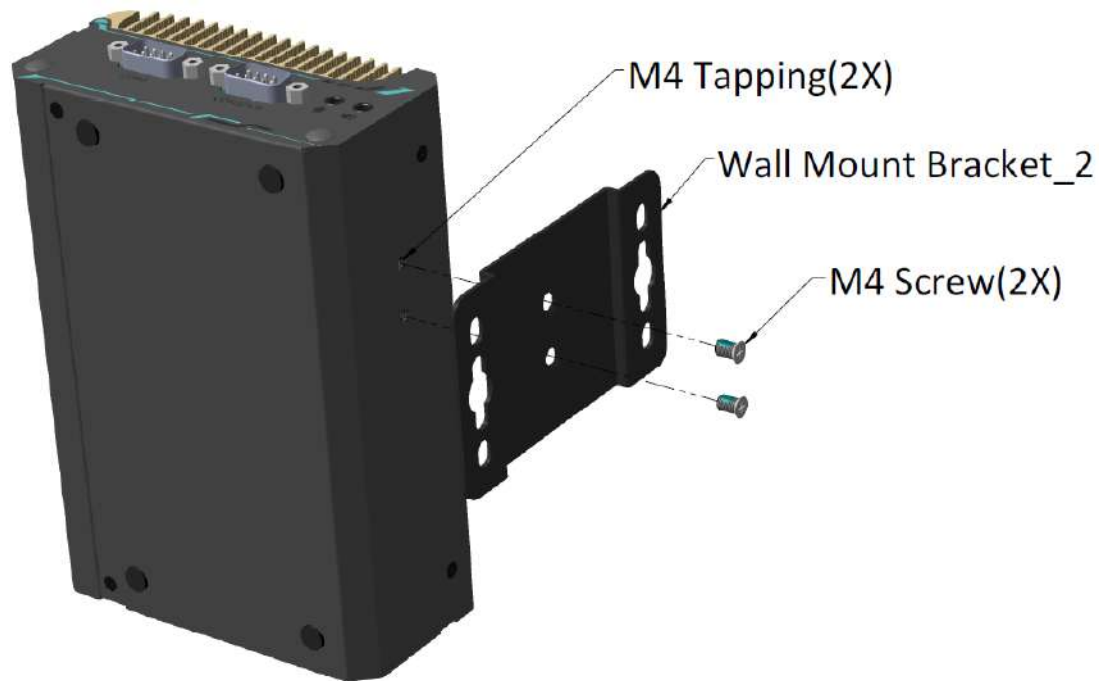

3. Once the wall mount bracket has been installed, it is ready to be secured onto the dedicated location.

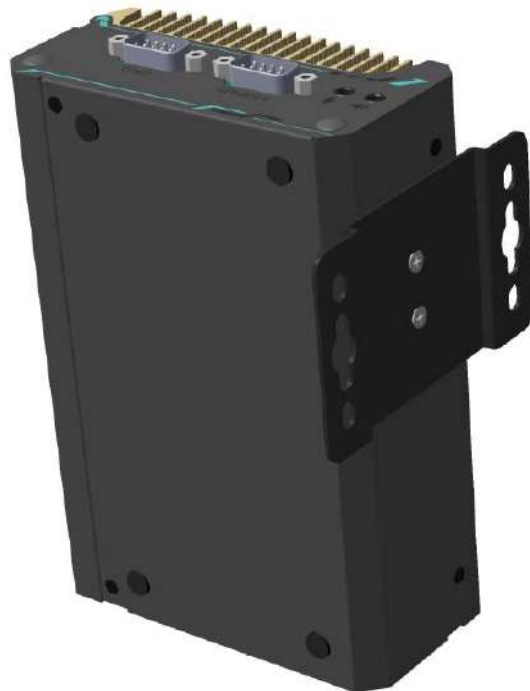

3.6 Wall Mount Bracket Installation (with WM-300H)

1. To install the full size wall mount bracket, locate a flat surface area (wall, ceiling, etc.) free from obstructions that meets the following dimensions.

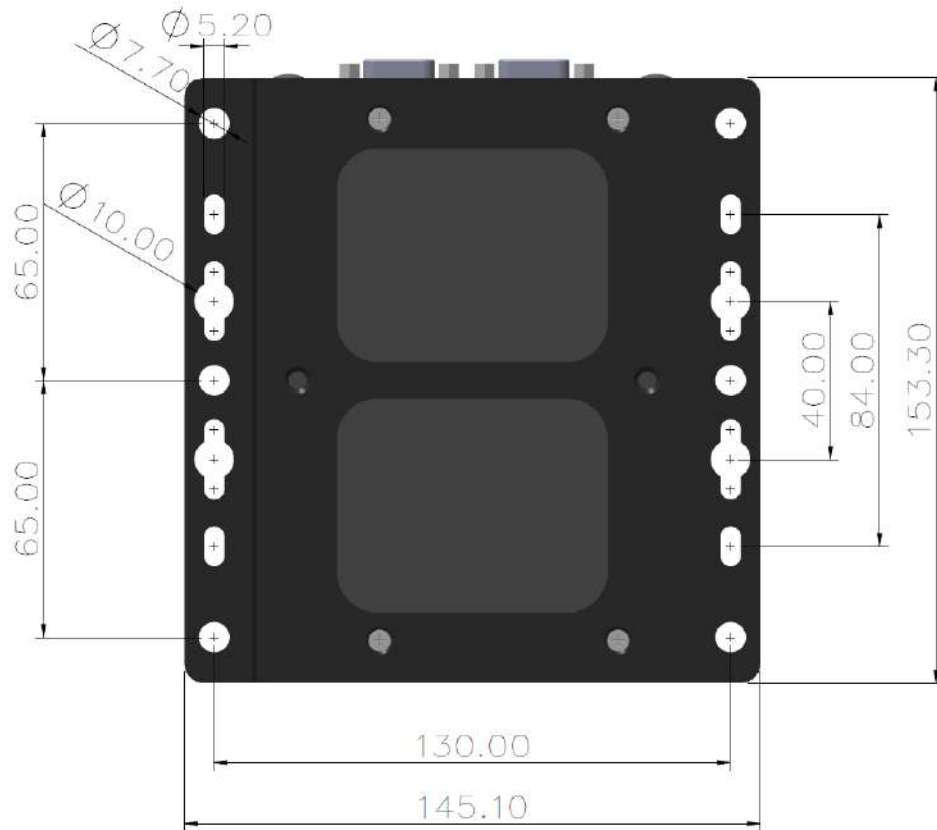

- To install, simply secure the WM-300H wall mount bracket with the four M4 screws supplied onto the enclosure shown below.

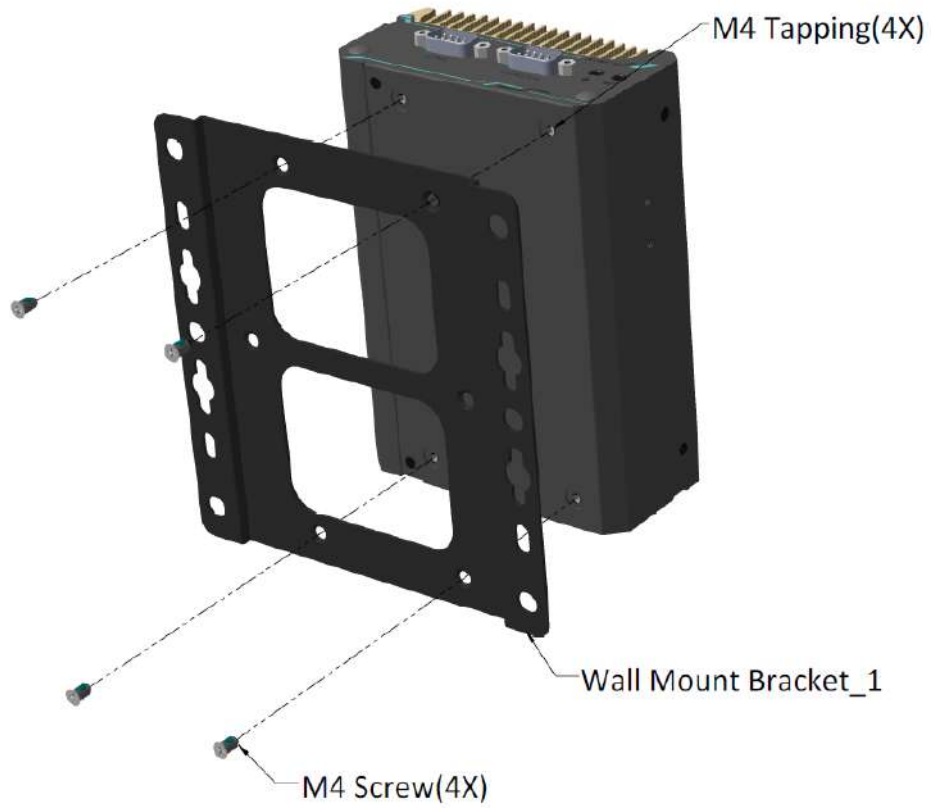

3. Once the full size wall mount bracket has been installed, it is ready to be secured onto the dedicated location.



3.7 Powering On the System

There are five methods to power on the system

- Pressing the power button
- Via an external non-latched switch
- Via an external latched switch
- Sending a LAN packet via Ethernet (Wake-on-LAN)
- Using the ignition signal input (if MezIO-V20 is implemented)

We will describe the processes and actions involved for the first four methods in this section and the ignition signal input method will be described in section 3.8.

3.7.1 Powering On Using the Power Button

This is the simplest way to turn on your system. The power button on the front panel is a non-latched switch and behaves as the ATX-mode on/off control. With DC power connected, pushing the power button will turn on the system and the PWR LED indicator will light up. Pushing the button when system is on will turn off the system. If your operating system supports ATX power mode (i.e. Microsoft Windows or Linux), pushing the power button while the system is in operation will result in a pre-defined system behavior, such as shutdown or hibernation.

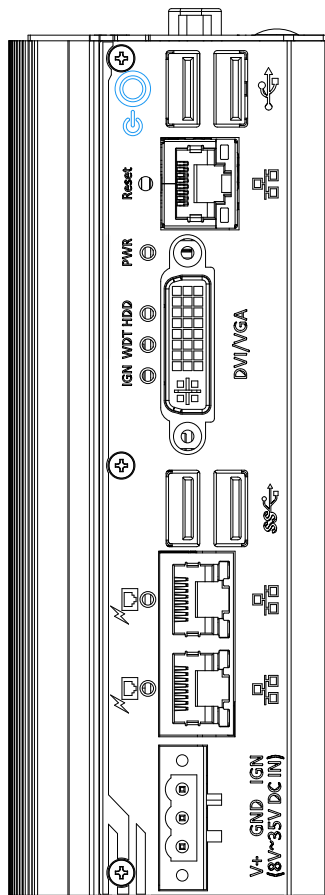

3.7.2 Powering On Using An External Non-Latched Switch

For an application which places the system inside a cabinet, it's useful to control powering on/off the system using an external switch. The system provides an on-board connector for connecting a latched/ non-latched switch and behaving either AT-mode or ATX-mode power on/off control.

When using the ATX-mode on/ off control, you need a non-latch switch. The external non-latched switch acts exactly the same as the power button on the front panel. Please follow the steps below to install an external non-latch switch.

1. Prepare a non-latched switch with a 2-pin, 2.0mm pitch connector

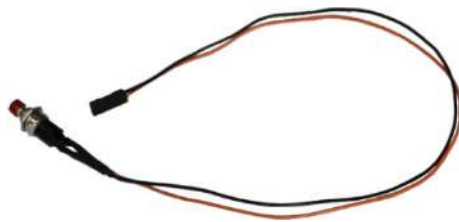

2. Connect the non-latched switch to the **pin#2** and **pin#3** of the on-board 1x3 pins, 2.0mm pitch pin header (polarity is negligible). Press the button on the switch to turn on the system.

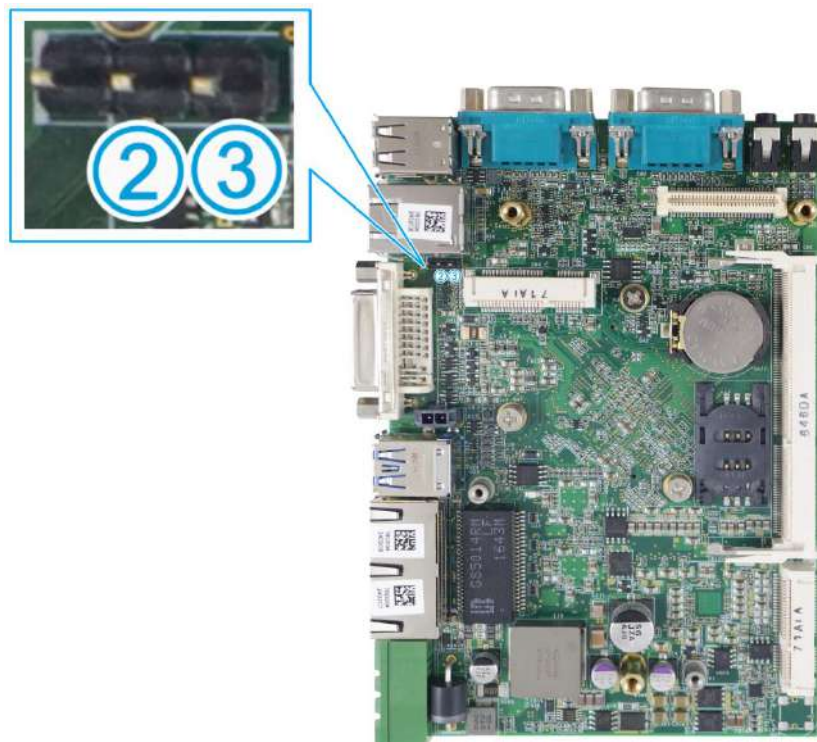

3.7.3 Powering On Using An External Latched Switch

For an application which places the system inside a cabinet, it's useful to control powering on/off the system using an external switch. The system provides an on-board connector for connecting a latched/ non-latched switch and behaving either AT-mode or ATX-mode power on/off control.

When using the AT-mode on/off control, you need a latched switch. The external latched switch controls the of DC power feed status. When the switch is closed, the DC power supply is in break-off status. When it's opened, the DC power supply is in feed-in status. Please follow the steps below to install an external latch switch.

1. Prepare a latched switch with a 2-pin, 2.0mm pitch connector.

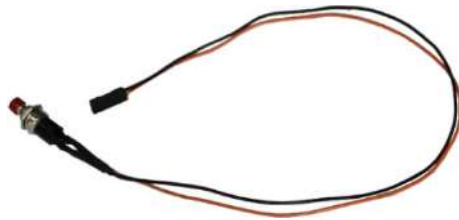

2. Connect the latched switch to the **pin#1** and **pin#2** of the on-board 1x3 pins, 2.0mm pitch pin header (polarity is negligible).

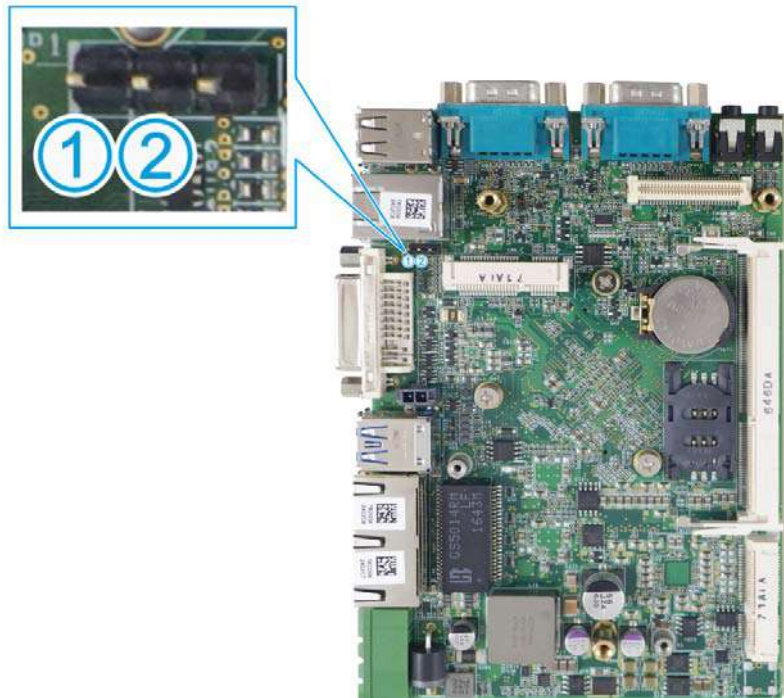

3. When the latched switch is closed, the DC power is in break-off status and system is turned off. When the latched switch is opened, the DC power is in feed-in status and with the correct setting of "[Power On after Power Failure](#)" BIOS option, the system is turned on.

3.7.4 Powering On Using Wake-on-LAN

Wake-on-LAN (WOL) is a mechanism to wake up a computer system from a S3 (standby), S4 (Hibernate) or S5 (system off with standby power) state via issuing Subnet Directed Broadcasts (SDB) or a magic packet. The system implements the Wake-on-LAN function for the GbE port #3 shown below.

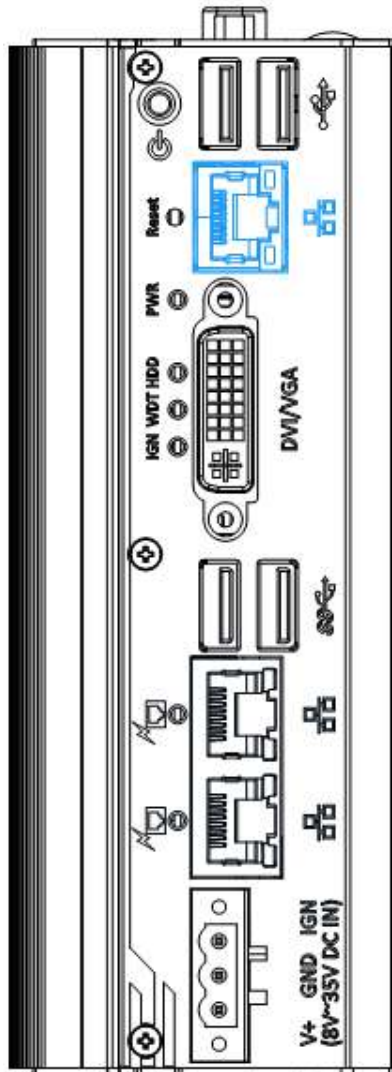

To enable WOL function and power on your system, please follow the steps below.

1. Press F2 when the system boots up to enter BIOS.
2. Enter the **[Power]** menu. And configure the **[Wake On LAN]** option as **[Enabled]**. Please refer to the [Wake-on-LAN](#) section.

- In Windows systems, identify the Local Area Connection of the corresponding Gigabit Controller and click the **Configure** button.

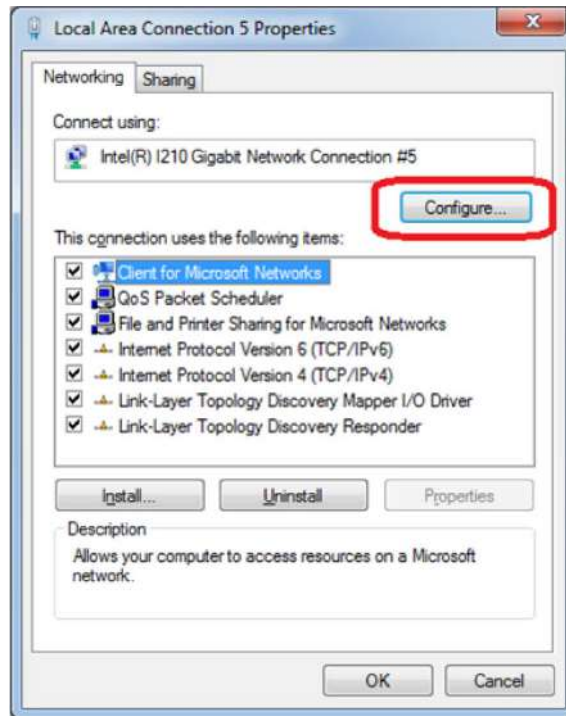

- Click the **Power Management** tag, and check the following two options accordingly

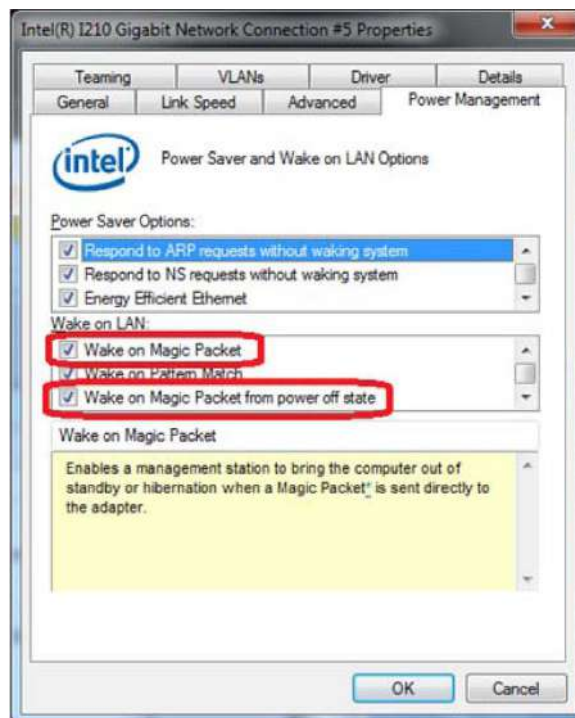

- **Wake on Magic Packet**

The system can wake from S3 or S4 state when receiving a magic packet. The magic packet is a broadcast frame containing anywhere within its payload 6 bytes of all 255 (FF FF FF FF FF FF in hexadecimal), followed by sixteen repetitions of the target computer's 48-bit MAC address.

For example, NIC's 48-bit MAC Address is 78h D0h 04h 0Ah 0Bh 0Ch

DESTINATION SOURCE MISC

FF FF FF FF FF FF

78 D0 04 0A 0B 0C 78 D0 04 0A 0B 0C

78 D0 04 0A 0B 0C 78 D0 04 0A 0B 0C

78 D0 04 0A 0B 0C 78 D0 04 0A 0B 0C

78 D0 04 0A 0B 0C 78 D0 04 0A 0B 0C

78 D0 04 0A 0B 0C 78 D0 04 0A 0B 0C

78 D0 04 0A 0B 0C 78 D0 04 0A 0B 0C

78 D0 04 0A 0B 0C 78 D0 04 0A 0B 0C

78 D0 04 0A 0B 0C 78 D0 04 0A 0B 0C

MISC CRC

There are some free tools available on Internet that can be used to send a magic packet. Please refer to the following link to understand more about Magic Packet.

<http://en.wikipedia.org/wiki/Wake-on-LAN>

- **Wake on Magic Packet from power off state**

When checking this option, the system can wake from S5 (system off with standby power) state when receiving a magic packet.

3.8 Ignition Power Control (For MezIO-V20 Only)

The ignition power control module for in-vehicle applications is a MCU-based implementation that monitors the ignition signal and reacts to turn on/off the system according to predefined on/off delay. Its built-in algorithm supports other features such as ultra-low power standby, battery-low protection, system hard-off, etc. In this section, we'll illustrate the principle of ignition power control and operation modes.

3.8.1 Principles of Ignition Power Control

The basic concept of ignition power control module is to control the timing correlation between ignition signal and system power status. A typical timing correlation is described in following diagram.

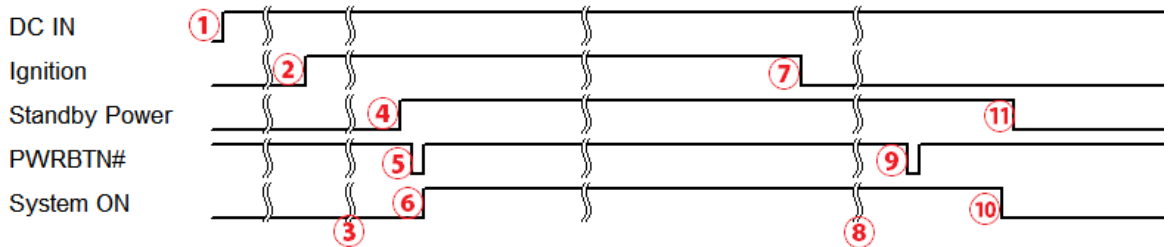

1. When DC power is supplied to the system, MCU starts to periodically detect ignition signal. Note that only MCU is working at this moment and the overall power consumption is less than 2 mW.
2. Ignition signal is active (both 12VDC and 24VDC ignition signals are accepted).
3. MCU starts to count a pre-defined power-on delay.
4. Once power-on delay expired, MCU turns on necessary standby power for the system (3.3VSB & 5VSB).
5. A PWRBTN# pulse is then issued to turn on the system (equivalent to one pressing the power button on the front panel).
6. The system is booting and becomes operational.
7. After a period of time, the ignition signal becomes inactive.
8. MCU starts to count a pre-defined power-off delay.
9. Once power-off delay expired, another PWRBTN# pulse is issued to perform a soft-off for the system (ex. a normal shutdown process for Windows system).
10. The system is completely shut down.
11. As MCU detects system is off, it turns off the standby power for the system, and operates in low power mode again (< 2mW power consumption).

3.8.2 Additional Features of Ignition Power Control

In addition to the typical timing correlation, the ignition power control module offers additional features to provide additional reliability for in-vehicle applications.

- **Low battery detection**

The ignition power control module continuously monitors the voltage of DC input when the system is operational. If input voltage is less than 9V (for 12VDC input) or less than 18V (for 24VDC input) over a 60-second duration, it will shut down the system automatically.

- **Guarded power-on/ power-off delay duration**

If ignition signal goes inactive during the power-on delay duration, the ignition power control module will cancel the power-on delay process and go back to idle status. Likewise if ignition signal goes active during the power-off delay duration, the ignition power control module will cancel the power-off delay process and keep the system running.

- **System hard-off**

In some cases, system may fail to shutdown via a soft-off operation due to system/ application halts. The ignition power control module offers a mechanism called “hard-off” to handle this unexpected condition. By detecting the system status, it can determine whether the system is shutting down normally. If not, the ignition power control module will force cut-off the system power 10 minutes after the power-off delay duration.

- **Smart off-delay**

The ignition power control module offers two modes (mode 6 & mode 7) which have very long power-off delay duration for applications require additional off-line time to process after the vehicle has stopped. In these two modes, the ignition power control module will automatically detect the system status during the power-off delay duration. If the system has shutdown (by the application software) prior to power-off delay expiring, it will cut off the system power immediately to prevent further battery consumption.

3.8.3 Wiring Ignition Signal

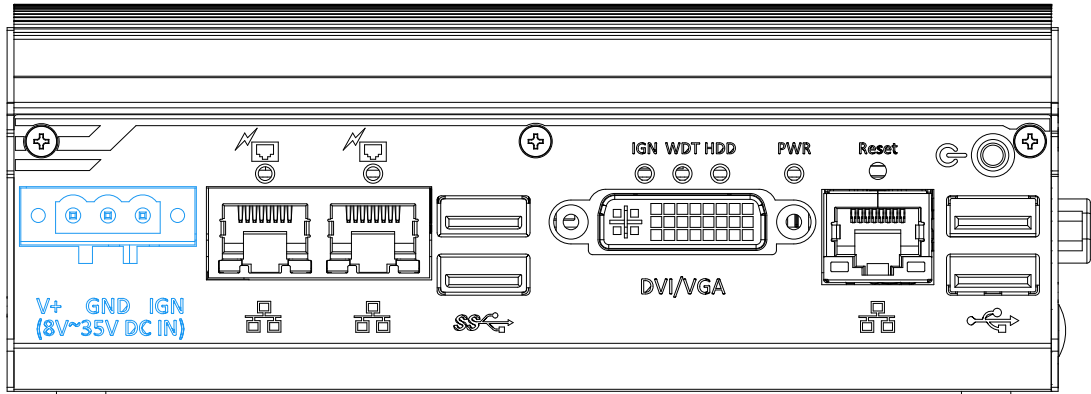

To have ignition power control for in-vehicle usage, you need to supply IGN signal to the system. The IGN input is located on the 3-pin pluggable terminal block (shared with DC power input). For in-vehicle ignition control wiring, please do the following:

1. Connect car Battery+ line (12V for sedan, 24V for bus/truck) to V+.
2. Connect car Batter-/ GND line to GND.
3. Connect ACC line to IGN.



WARNING

Please make sure your DC power source and IGN signal share the same ground. IGN input accepts 8~35VDC. Supply a voltage higher than 35VDC may damage the system.

3.8.4 Configure your Windows system

When applying ignition power control to your system, please make sure you've configured your Windows system to initiate a shutdown process when pressing the power button. By default, Windows 7/ 8/ 10 goes to sleep (S3) mode when power button is pressed. As sleep (S3) is not a complete shutdown behavior, the ignition control function does not recognize the finish of a normal shut down process and thus users will encounter a system hard-off (power cut-off after 10 minutes). Please configure "When I press the power button" to "Shut down" in your Windows system settings.

Power button settings

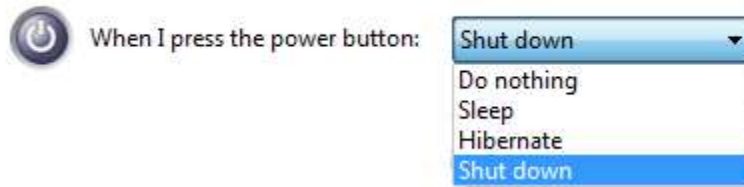

3.8.5 Operation Modes of Ignition Power Control

You can use the rotary switch to configure the operation mode. The system offers 16 (0~15) operation modes with different power-on/power-off delay configurations.

The ignition control module is also BIOS-configurable. When rotary switch is set to mode 15 (0xF), the ignition power control is set to executed according to parameters configured in BIOS setup menu, which allows richer combination of power-on/power-off delay and more detailed control parameters.



- **Mode 0**

Mode 0 is the ATX mode without power-on and power-off delay. User can only use the power button on the front panel to turn on or turn off the system.

Mode	Power-on Delay	Power-off Delay	Hard-off Timeout
0	N/A	N/A	N/A

- **Mode 1**

Mode 1 is AT mode without power-on and power-off delay. The system automatically turns on when DC power is applied. A retry mechanism is designed to repeat the power-on cycle if the system fails to boot up.

Mode	Power-on Delay	Power-off Delay	Hard-off Timeout
1	N/A	N/A	N/A

- **Mode 2**

Mode 2 is designed to have a very minor power on/ off delay of 160ms for applications that requires the system to start up almost at the same as the rest of the equipment it is working in collaboration with.

Mode	Power-on Delay	Power-off Delay	Hard-off Timeout
2	160ms	160ms	10 minutes

- **Mode 3 ~ Mode 12**

Mode 3 ~ Mode 12 have various power-on delay and power-off delay. Each mode supports a hard-off timeout of 10 minutes.

Mode	Power-on Delay	Power-off Delay	Hard-off Timeout
3	10 seconds	10 seconds	10 minutes
4	10 seconds	1 minute	10 minutes
5	10 seconds	5 minutes	10 minutes
6	30 seconds	1 minute	10 minutes
7	30 seconds	5 minutes	10 minutes
8	30 seconds	10 minutes	10 minutes
9	3 minutes	1 minute	10 minutes
10 (A)	3 minutes	10 minutes	10 minutes
11 (B)	3 minutes	30 minutes	10 minutes
12 (C)	10 minutes	30 minutes	10 minutes

- **Mode 13 (D) / Mode 14 (E)**

Mode 13 and Mode 14 are ignition power control modes with very long power-off delay. Both modes support the feature of “smart off-delay”, which automatically detect system status during power-off delay duration and cut off system power if system is off in prior to power-off delay expired.

Mode	Power-on Delay	Power-off Delay	Hard-off Timeout
13 (D)	30 seconds	2 hours	10 minutes
14 (E)	3 minutes	2 hours	10 minutes

- **Mode 15 (F)**

Mode 15 is reserved for manufacturer purposes.

4 BIOS Settings

The system is shipped with factory-default BIOS settings optimized for best performance and compatibility. In this section, we'll illustrate some BIOS settings you may need to set or change prior to operating system installation. Please always make sure you understand the effect of change before you proceed with any changes. If you are unsure of the function you are changing, it is recommended to change one setting at a time to see its effect(s).

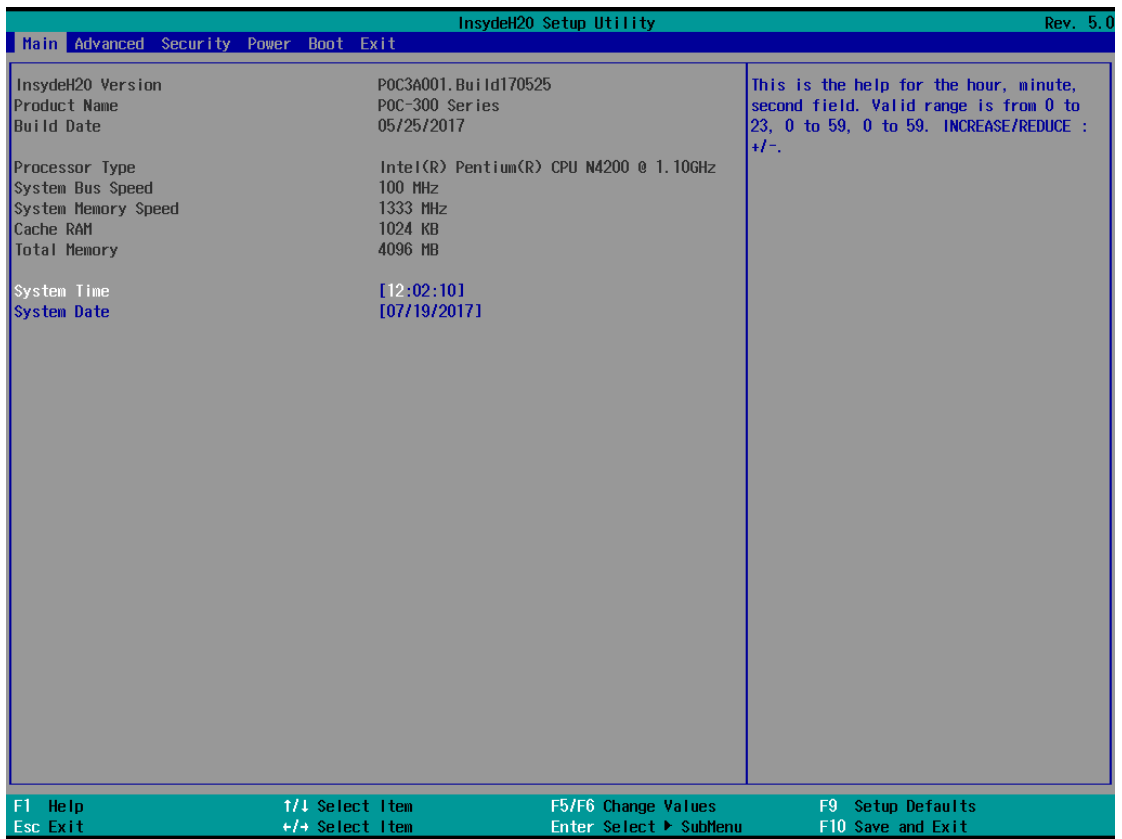

4.1 COM1 Port Configuration

The system's [COM1 port](#) supports RS-232 (full-duplex), RS-422 (full-duplex) and RS-485 (half-duplex) mode. You can set the COM1 operating mode via BIOS settings. Another option in BIOS called “*Slew Rate*” defines how sharp the rising/falling edge is for the output signal of COM1. For long-distance RS-422/485 transmission, you may set the “*Slew Rate*” option as “High” to improve signal quality. For RS-422/485 communication, the “*RS-422/485 Termination*” option determines whether to enable/disable internal termination of RS-422/485 transceiver according to your wiring configuration (e.g. with or without external termination).

To set COM1 operating mode:

1. Press **F2** when the system boots up to enter the BIOS setup utility.
2. Go to **[Advanced]** → **[Peripheral Configuration]**.
3. Set the **[Set COM1 Mode as]** option to the desired mode.
4. Once set, press **F10** to save setting and exit.



4.2 COM2/ 3/ 4 Port Configuration

The system's [COM2/ 3/ 4 ports](#) support RS-232 (full-duplex) while COM2 also supports RS-422 (full-duplex) and RS-485 (half-duplex) mode. The operating mode can be configured via the BIOS. Another option in BIOS called “Slew Rate” defines how sharp the rising/falling edge is for the output signal. For long-distance RS-422/485 transmission, you may set the “Slew Rate” option as “High” to improve signal quality. For RS-422/485 communication, the “RS-422/485 Termination” option determines whether to enable/disable internal termination of RS-422/485 transceiver according to your wiring configuration (e.g. with or without external termination).

To set COM2/ 3/ 4 operating mode:

1. Press **F2** when the system boots up to enter the BIOS setup utility.
2. Go to **[Advanced]** → **[Peripheral Configuration]**.
3. Set the **[Set COM2/ 3/ 4 Mode as]** option to the desired mode.
4. Once set, press **F10** to save setting and exit.

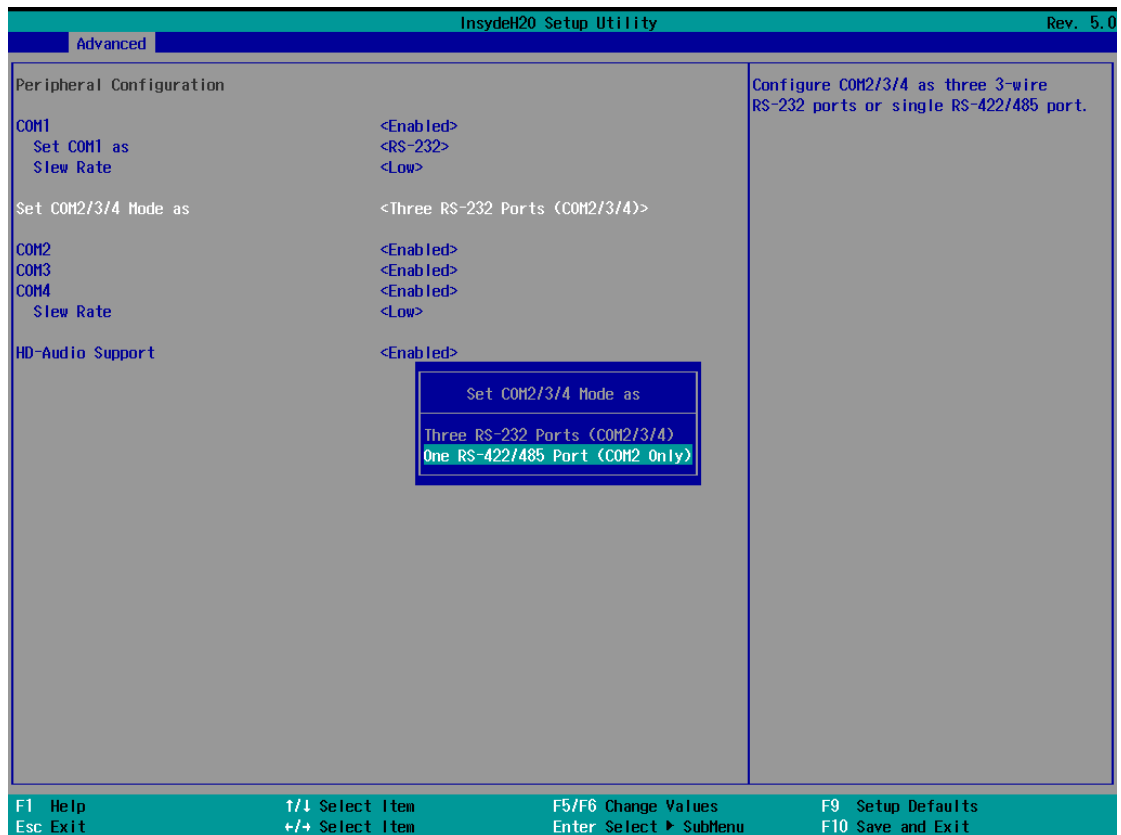

4.3 SATA Interface Speed

The system's SATA controller supports three modes of operations, <Gen1>, <Gen2> and <Gen3>. Gen 1 SATA mode offers bandwidth throughput of up to 150MB/s; Gen 2 SATA mode offers bandwidth throughput of up to 300MB/s; Gen 3 SATA mode offers bandwidth throughput of up to 600MB/s. For systems with only mSATA module installed, Gen 2 is recommended. For systems with Mezio-R11/ R12 and 2.5" SSD, you can set this option to Gen2/ Gen3 according to SSD's specifications.

To set Chipset SATA mode:

1. Press **F2** when the system boots up to enter the BIOS setup utility.
2. Go to **[Advanced] → [SATA Configuration]**.
3. Set the **[SATA Interface Speed]** option to the desired mode.
4. Once set, press **F10** to save setting and exit.

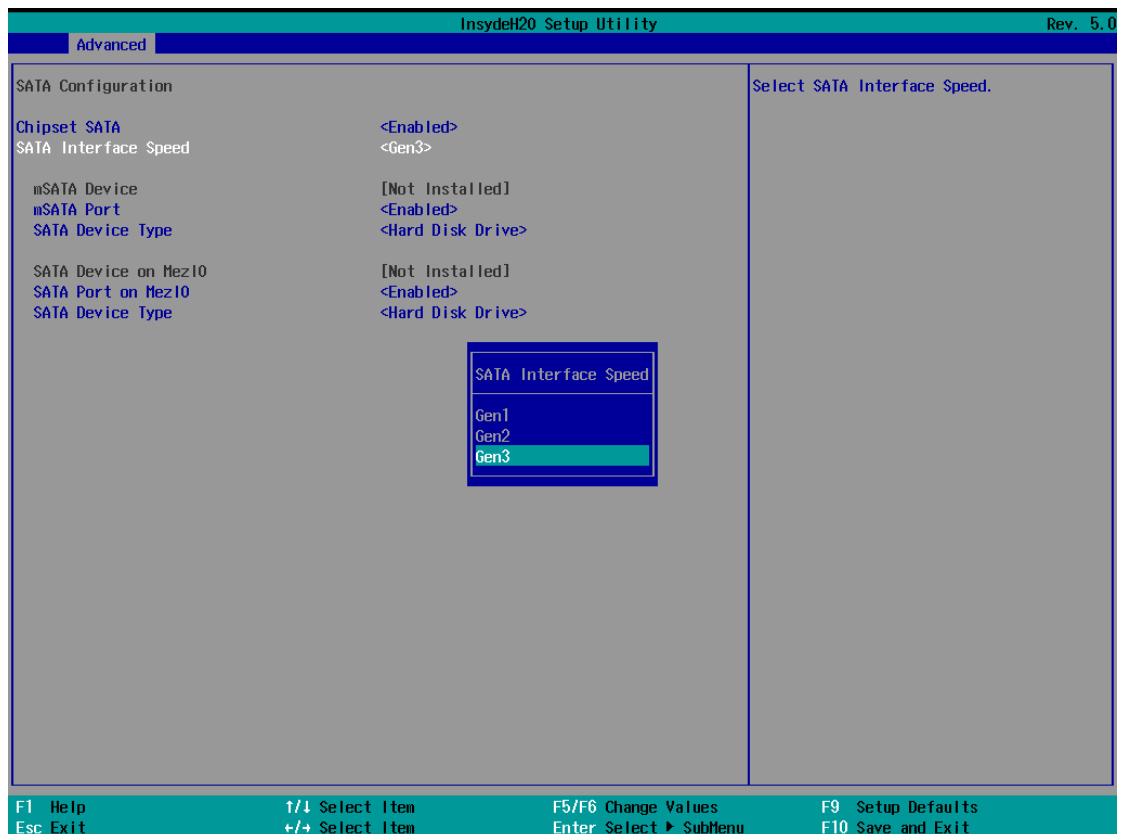

4.4 C-States

C-States is a power-saving technique implemented in modern Intel processors. It shuts down the clock signals and power for idle logic units inside the CPU to save the energy consumed. The trade-off, however, is a longer latency for CPU to wake up and be 100% operational. Depending on your application, you can configure these options to have higher performance (disable “C-States”) or lower power-consumption (enable “C-States”).

To set C-States and Enhanced C-States:

1. Press **F2** when the system boots up to enter the BIOS setup utility.
2. Go to **[Power]** → **[CPU Configuration]** → **[CPU Power Management]**
3. Enable/disable the **[C-States]** option according to your application.
4. Once set, press **F10** to save setting and exit.

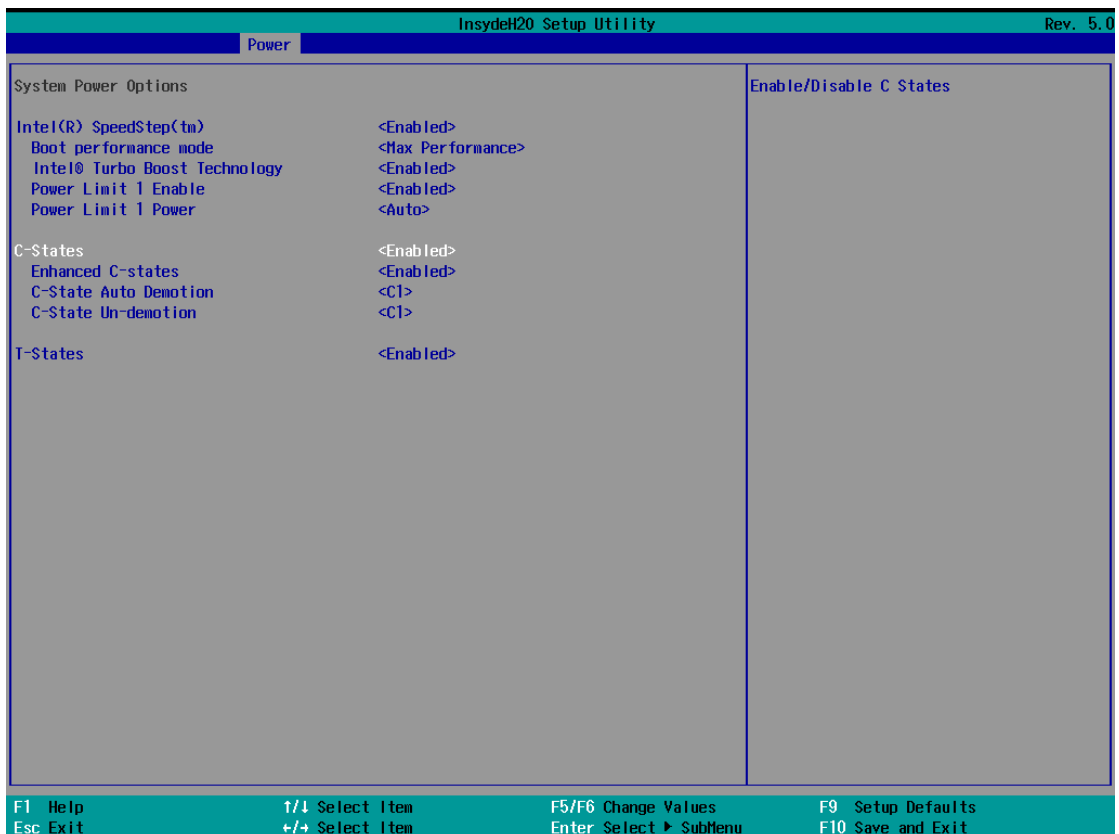

4.5 Wake-on-LAN

Wake-on-LAN (WOL) is a mechanism which allows you to turn on your system via Ethernet connection. To utilize Wake-on-LAN function, you have to enable this option first in BIOS settings. Please refer to Powering on via Wake-on-LAN function.

To enable/disable “Wake on LAN” option:

1. Press **F2** when the system boots up to enter the BIOS setup utility.
2. Go to **[Power]**.
3. You may enable/disable the **[Wake on LAN]** option.
4. Once set, press **F10** to save setting and exit.

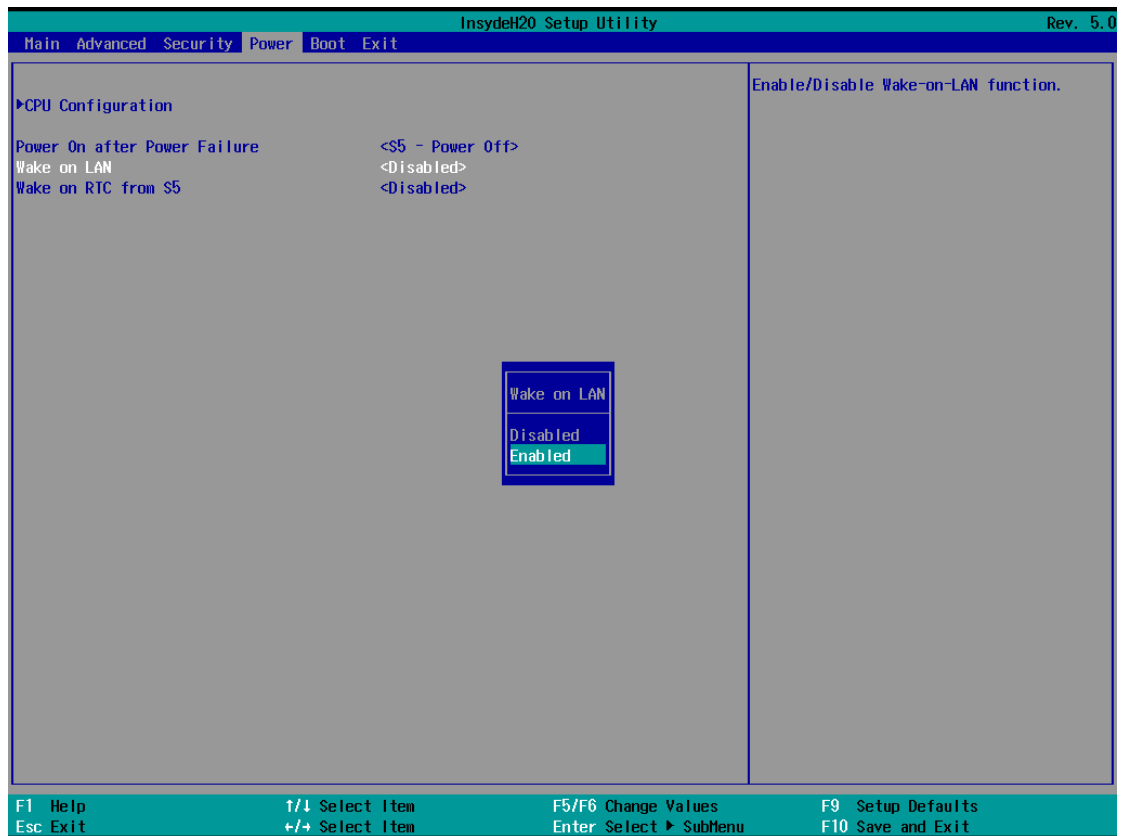

4.6 Power On after Power Failure

This option defines the system's behavior when DC power is supplied.

Value	Description
S0 – Power On	System is powered on when DC power is supplied.
S5 – Power Off	System is kept in off state when DC power is supplied.
Last State	Last system operating state when DC power loss occurred.

When you want to use the AT-mode remote on/off control function, you have to set this option to “S0 – Power On”. Please refer to [section 3.7.2](#) for instructions of using AT-mode remote on/off control function.

To set “Power On after Power Failure” option:

1. Press **F2** when the system boots up to enter the BIOS setup utility.
2. Go to **[Power]**.
3. Set the **[Power On after Power Failure]** option to the desired setting.
4. Once set, press **F10** to save setting and exit.

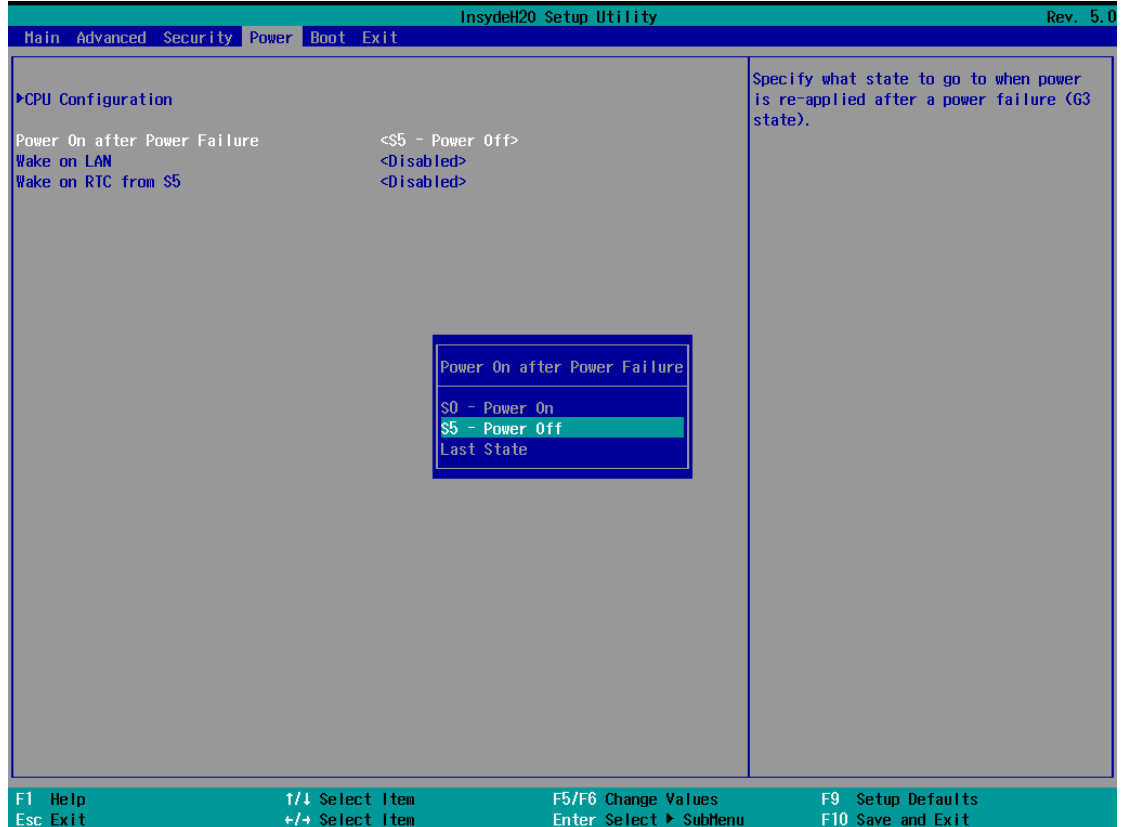

4.7 Position New Boot Device

The “Add Boot Options” allow you to determine whether a newly added device (eg. USB flash disk) is to boot as the first device to boot or the last in the boot sequence.

To set the newly-installed boot device as the first or last boot device:

1. Press **F2** when the system boots up to enter the BIOS setup utility.
2. Go to **[Boot] > [Add Boot Options]** menu.
3. Select **[First]** or **[Last]** for your newly-added boot device and press Enter.
4. Once set, press **F10** to save setting and exit.

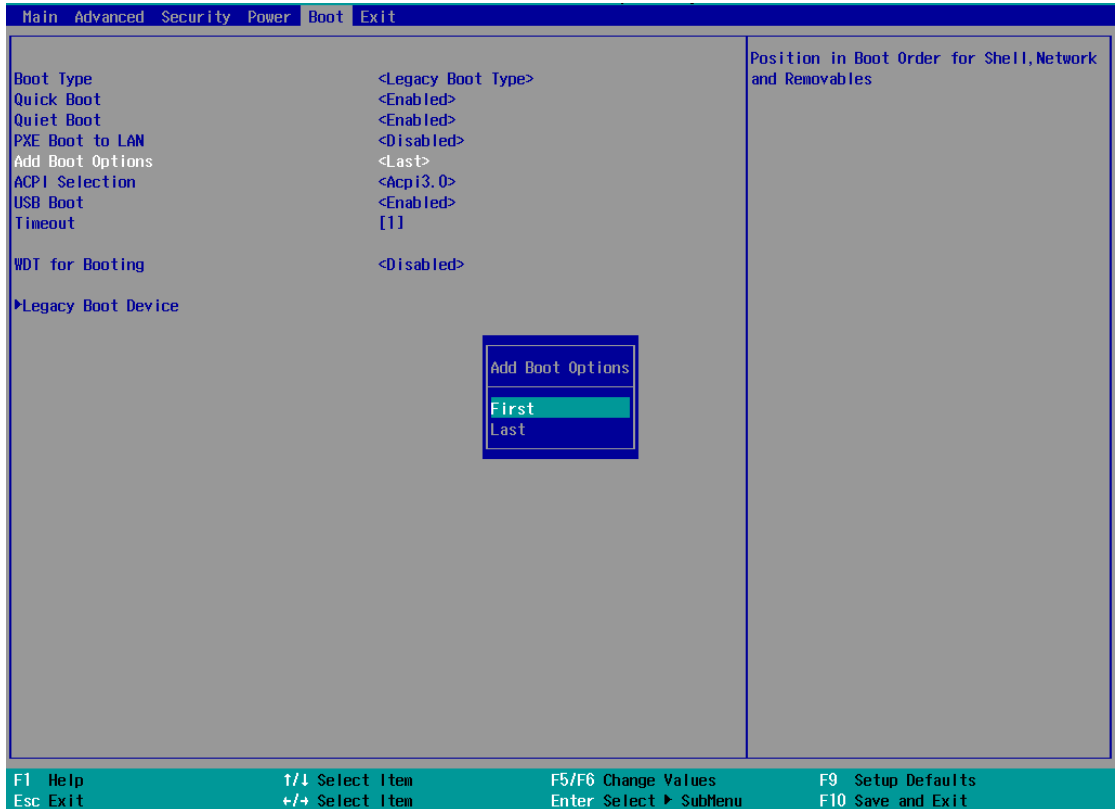

4.8 Watchdog Timer

The watchdog timer secures the boot process by means of a timer. Once the timer expires, a reset command is issued to initiate another booting process. There are two options in BIOS menu, “*Automatically after POST*” and “*Manually after Entering OS*”. When “*Automatically after POST*” is selected, the BIOS automatically stops the watchdog timer after POST (Power-On Self Test) OK. When “*Manually after Entering OS*” is selected, the user must stop the watchdog timer once booted into the OS. This guarantees the system can always boot into the OS, otherwise another booting process will be initiated. For information about programming watchdog timer, please refer to [Appendix A Using WDT & DIO](#).

To set the watchdog timer for boot in BIOS:

1. Press **F2** when the system boots up to enter the BIOS setup utility.
2. Go to **[Boot]** menu.
3. Disable or select timeout value for **[WDT for Booting]** option.
4. Once you set a timeout value, the **[WDT Stop Option]** option appears. You can select either “*Automatically after POST*” or “*Manually after Entering OS*”.
5. Once set, press **F10** to save setting and exit.



4.9 Select a Boot Device

When you have multiple bootable devices connected to your system and you may set which device as the first boot device. There are two ways to select the device. One, press F12 upon system boot up to go to Boot Manager and then select one of the devices, or two, set a default boot device in the BIOS.

To select a boot device in BIOS:

1. When system boots up, press F2 to enter BIOS setup utility.
2. Go to **[Boot] → [Boot Menu]**.
3. The **[Boot Menu]** option determines whether to list all bootable devices connected to your system according to device or device type. The default order of boot device type is
 - Hard Disk Drive
 - USB
 - CD/DVD-ROM Driver
 - Others

You can use F5/F6 or +/- to change the boot order of devices or device types.

4. Once set, press **F10** to save setting and exit.

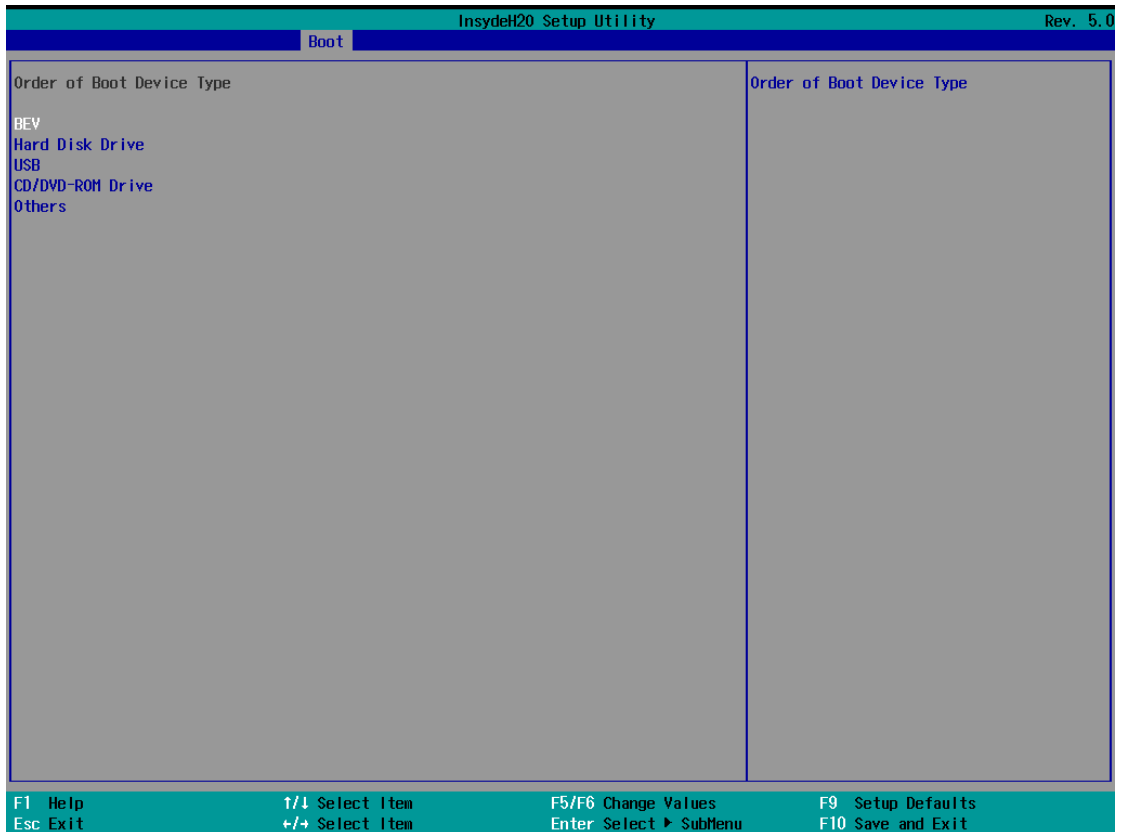

5 OS Support and Driver Installation

5.1 Operating System Compatibility

Due to Intel's policy, POC-300 series only provide driver support for Windows 10 64-bit. For Linux support, please use Linux kernel versions no later than 4.10. The following list contains the operating systems which have been tested in Neosys Technology Inc.

- Microsoft Windows 10 Professional 64-bit
- Microsoft Windows 10 IoT Enterprise 64-bit
- Ubuntu 16.04.3 LTS** (4.10 kernel)



NOTE

**For Linux system, user may need to manually compile and install the driver for Intel graphics or I210 GbE controller if the driver is not embedded in kernel. You can visit Intel website for further information.*

Neosys may remove or update operating system compatibility without prior notice. Please contact us if your operating system of choice is not on the list.

5.2 Driver Installation

The system comes with a “Drivers & Utilities” DVD that offers “one-click” driver installation process. It automatically detects your Windows operating system and installs all necessary drivers for your system with a single click.

5.2.1 Install Drivers Automatically

To install drivers automatically, please refer to the following procedures.

1. Insert the “Drivers & Utilities” DVD into a USB DVD-drive connect to your system. A setup utility launches and the following dialog appears.



2. Click on “**Automatic Driver Installation**” and the setup utility will automatically detect your Windows operating system and install all necessary drivers. The installation process takes about 6~8 minutes depending on your Windows version. Once driver installation is done, the setup utility reboots your Windows and you may begin using your system.

5.2.2 Install Drivers Manually

You can also manually install each driver for the system. Please note when installing drivers manually, you need to install the drivers in the following sequence mentioned below.

Windows 10 (x64)

The recommended driver installation sequence is

1. **Chipset driver** (x:\Driver_Pool\Chipset_10_APL\Win_ALL\SetupChipset.exe)
2. **Graphics driver**
(x:\Driver_Pool\Graphics_SKL_APL\Win_7_8_10_APL_64\Setup.exe)
3. **Audio driver** (x:\Driver_Pool\Audio_ALC262\Win_ALL_64\Setup.exe)
4. **LAN driver**
(x:\Driver_Pool\GbE_I210_I350\Win_ALL_64\APPS\PROSETDX\Winx64\DxSetup.exe)
5. **TXE driver** (x:\Driver_Pool\TXE_APL\Win_10_64\SetupTXE.exe)

5.3 Driver for Watchdog Timer and DIO

Neosys provides a driver package which contains function APIs for WDT function and isolated DIO control function (when MezIO-R12, D230 or D220 is installed). You should install the driver package (WDT_DIO_Setup.exe) in prior to use these functions. Please note that you must install WDT_DIO_Setup_v2.2.6 or later versions.



NOTE

Please install WDT_DIO_Setup_v2.2.6 or later versions.

Windows 7/ 8/ 10 (x64)

Please execute the driver setup program in the following directory.

x:\Driver_Pool\WDT_DIO\Win7_8_10_64\WDT_DIO_Setup_v2.2.6(x64).exe

Windows 7/ 8/ 10 (WOW64)

Please execute the driver setup program in the following directory.

x:\Driver_Pool\WDT_DIO\Win7_8_10_WOW64\WDT_DIO_Setup_v2.2.6(wow64).exe

Appendix A Using WDT & DIO

The watchdog timer (WDT) function to ensure reliable system operation. The WDT is a hardware mechanism to reset the system if the watchdog timer is expired. Users can start the WDT and keeping resetting the timer to make sure the system or program is running. Otherwise, the system shall be reset.

In this section, we'll illustrate how to use the function library provided by Neosys to program the WDT functions. Currently, WDT driver library supports Windows 10 x64 and WOW64 platform. For other OS support, please contact Neosys Technology for further information.

Installing WDT_DIO Library

The WDT_DIO function library is delivered in the form of a setup package named **WDT_DIO_Setup.exe**. In prior to program WDT, you should execute the setup program and install the WDT library. Please use the following WDT_DIO_Setup packages according to your operating systems and application.

- For Windows 10 64-bit OS with 64-bit application (x64 mode), please install WDT_DIO_Setup_v2.2.6(x64).exe or later version.
- For Windows 10 64-bit OS with 32-bit application (WOW64 mode), please install WDT_DIO_Setup_v2.2.6(wow64).exe or later version.

WDT and DIO Library Installation

To setup WDT & DIO Library, please follow instructions below.

1. Execute **WDT_DIO_Setup.2.2.6.exe**. and the following dialog appears.

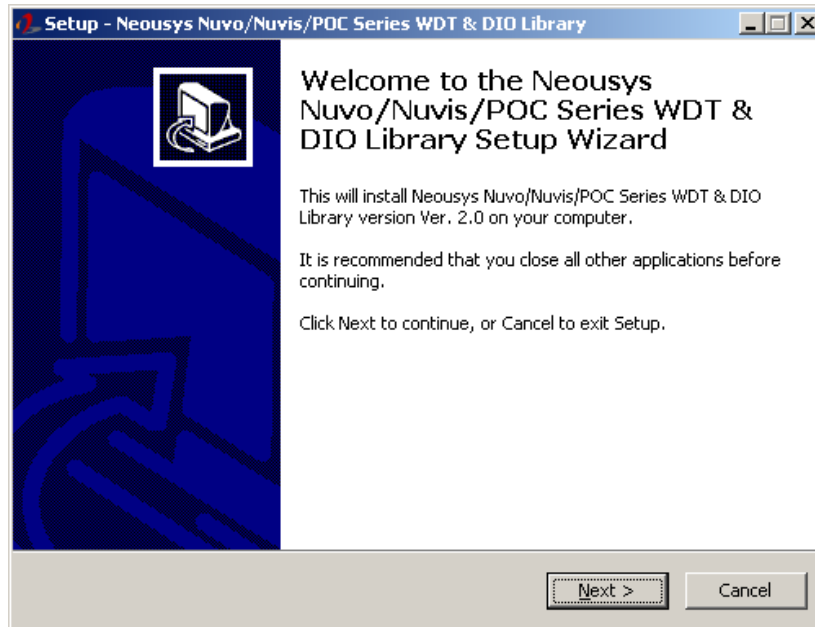

2. Click "Next >" and specify the directory of installing related files. The default directory is *C:\Neosys\WDT_DIO*.

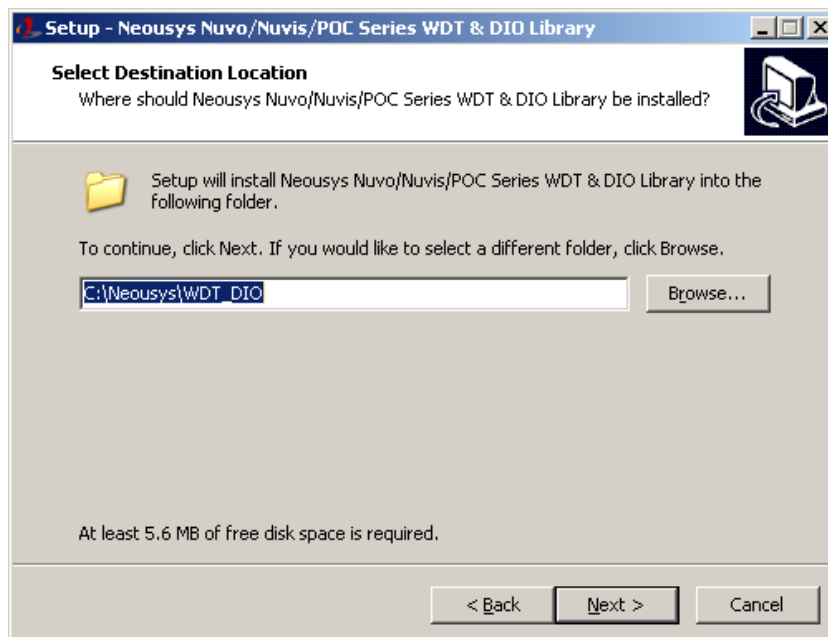

- Once the installation has finished, a dialog will appear to prompt you to reboot the system. The WDT & DIO library will take effect after the system has rebooted.

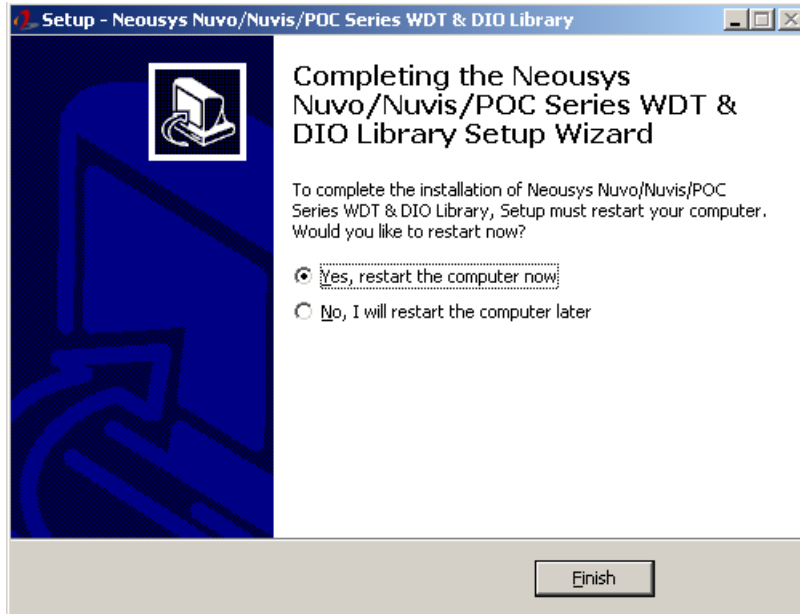

- When programming your WDT or DIO program, the related files are located in

Header File:	\Include
Library File:	\Lib
Function Reference:	\Manual
Sample Code:	\Sample\WDT_Demo (Demo for Watchdog Timer) \Sample\DIO_Demo (Demo for isolated DIO Control) \Sample\COS_Demo (Demo for change-of-state DI)

□□

WDT Function Reference

InitWDT

Syntax	BOOL InitWDT(void);
Description:	Initialize the WDT function. You should always invoke InitWDT() before set or start watchdog timer.
Parameter	None
Return Value	TRUE: Successfully initialized FALSE: Failed to initialize
Usage	BOOL bRet = InitWDT()

SetWDT

Syntax	BOOL SetWDT(WORD tick, BYTE unit);
Description	Set timeout value and unit for watchdog timer. When InitWDT() is invoked, a default timeout value of 255 seconds is assigned.
Parameter	<i>tick</i> WORD value (1 ~ 65535) to indicate timeout ticks. <i>unit</i> BYTE value (0 or 1) to indicate unit of timeout ticks. 0 : unit is minute 1: unit is second
Return Value	If value of unit is correct (0 or 1), this function returns TRUE, otherwise FALSE.
Usage	WORD tick=255; BYTE unit=1; //unit is second. BOOL bRet = SetWDT(tick, unit); //timeout value is 255 seconds

StartWDT

Syntax	BOOL StartWDT(void);
Description	Starts WDT countdown. Once started, the WDT LED indicator will begin blinking. If ResetWDT() or StopWDT is not invoked before WDT countdowns to 0, the WDT expires and the system resets.
Parameter	None
Return Value	If the timeout value is given in correct format (WDT started), this function returns TRUE, otherwise FALSE
Usage	BOOL bRet = StartWDT();

ResetWDT

Syntax	BOOL ResetWDT(void);
Description	Reset the timeout value to the value given by SetWDT().If ResetWDT() or StopWDT is not invoked before WDT countdowns to 0, the WDT expires and the system resets.
Parameter	None
Return Value	Always returns TRUE
Usage	BOOL bRet = ResetWDT();

StopWDT

Syntax	BOOL StopWDT(void);
Description	Stops the countdown of WDT. When WDT has stopped, the WDT LED indicator stops blinking.
Parameter	None
Return Value	Always returns TRUE
Usage	BOOL bRet = StopWDT();

Using DIO Function (With MezIO-R12 Installed)

Wiring for DIO

The digital input function of System series is implemented using a photo-coupler with an internally series-connected 1kΩ resistor. You need to provide a voltage to specify the logic high/low state. The input voltage for logic high is 5~24V, and the input voltage for logic low is 0~1.5V.

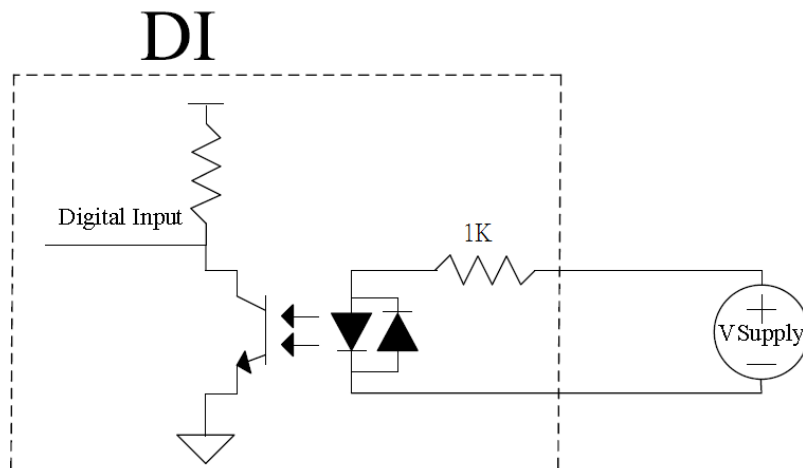

The digital output function of System series is implemented using Power MOSFET + Analog Device iCoupler® component. The DO channels are configured as NO (normally-open) configuration. When you turn on system, all DO channels have a deterministic state of logic 0 (circuit disconnected from GND return). When logic 1 is specified, MOSFET is activated and GND return path is established. The digital output function on System series supports sinking current connection. The following diagrams are the suggested wiring for DO:

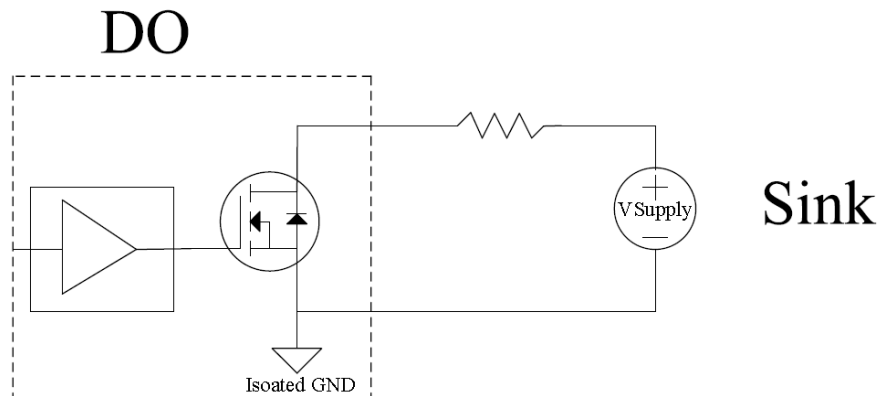

DIO Pin Definition

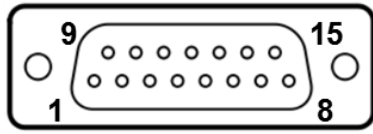

Pin#	Pin Definition	Pin#	Pin Definition
1	DI_0	9	DI_GND
2	DI_1	10	DI_2
3	DI_GND	11	DI_3
4	DO_GND	12	DO_GND
5	DO_0	13	DO_2
6	DO_1	14	DO_3
7	DO_GND	15	-
8	VDD		

DIO Function Reference

InitDIO

Syntax	BOOL InitDIO(void);
Description:	Initialize the DIO function. You should always invoke InitDIO() before write/read any DIO port/channel.
Parameter	None
Return Value	TRUE: Successfully initialized FALSE: Failed to initialize
Usage	BOOL bRet = InitWDT();

DIReadLine

Syntax	BOOL DIReadLine(BYTE ch);
Description:	Read a single channel of isolated digital input.
Parameter	<i>ch</i> BYTE value specifies the DI channel to be read. <i>ch</i> should be a value of 0 ~ 3.
Return Value	The status (TRUE or FALSE) of the specified DI channel.
Usage	BYTE ch=3; //DI channel #3 BOOL DIChValue = DIReadLine(ch); //read DI channel #3

DIReadPort

Syntax	WORD DIReadPort(void);
Description:	Read the entire isolated digital input port (4 channels).
Parameter	None
Return Value	The status (TRUE or FALSE) of the specified DI channel.
Usage	WORD DIPortValue = DIReadPort ();

DOWriteLine

Syntax	void DOWriteLine(BYTE ch, BOOL value);
Description:	Write a single channel of isolated digital output.
Parameter	<p><i>ch</i> BYTE value specifies the DO channel to be written. <i>ch</i> should be a value of 0 ~ 3.</p> <p><i>value</i> BOOL value (TRUE or FALSE) specifies the status of DO channel.</p>
Return Value	None
Usage	<pre> BYTE ch=3; //DI channel #3 BOOL DOChValue=TRUE; DOWriteLine(ch, DOChValue); //write DO channel #3 as TRUE </pre>

DOWritePort

Syntax	void DOWritePort(WORD value);
Description:	Write the entire isolated digital output port (4 channels).
Parameter	<p><i>value</i> WORD value specifies the status of the DO port. <i>value</i> should be a value of 0~15.</p>
Return Value	None
Usage	<pre> WORD DOPortValue=0x0C; //1100b DOWritePort(DOPortValue); //write DO port as 1100b </pre>

DOWriteLineChecked

Syntax	void DOWriteLineChecked(BYTE ch, BOOL value);
Description:	Write a single channel of isolated digital output and read-back the value of DO register. Note that this function is not returned until the DO register is checked and identical to the written value.
Parameter	<p><i>ch</i> BYTE value specifies the DO channel to be written. <i>ch</i> should be a value of 0 ~ 3.</p> <p><i>value</i> BOOL value (TRUE or FALSE) specifies the status of DO channel.</p>
Return Value	None
Usage	<pre> BYTE ch=3; //DI channel #3 BOOL DOChValue=TRUE; DOWriteLineChecked(ch, DOChValue); //write DO channel #3 as TRUE </pre>

DOWritePortChecked

Syntax	void DOWritePortChecked(WORD value);
Description:	Write the entire isolated digital output port (8 channels) and check it has been done. Note that this function is not returned until the write value has been checked the same with the device registry.
Parameter	<p><i>value</i> WORD value specifies the status of the DO port. <i>value</i> should be a value of 0~15.</p>
Return Value	None
Usage	<pre> WORD DOPortValue=0x0C; //1100b DOWritePortChecked(DOPortValue); //write DO port as 1100b </pre>

COS Function Reference

SetupDICOS

Syntax	<pre> BOOL SetupDICOS(COS_INT_SETUP *lpSetup, DWORD cbSetup); </pre>
Description	Setup Digital-Input(DI) Change-of-State(COS) interrupt parameters.
Parameter	<p><i>lpSetup</i> [in] A pointer to a COS_INT_SETUP structure that contains the COS configuration information for the DI device. This data structure contains the following variables:</p> <p><i>portMask</i> WORD value specifies the interrupt mask for corresponding channel(s).</p> <p><i>edgeMode</i> WORD value specifies that interrupt is generated when level change (set to 0) or on rising/falling edge (set to 1) for the corresponding channel(s).</p> <p><i>edgeType</i> WORD value specifies that interrupt is generated on rising edge (set to 0) or falling (set to 1) edge for corresponding channel(s). This value is neglected if <i>edgeMode</i> is set to 0 for the corresponding channel(s).</p> <p><i>cbSetup</i> [in] The length of the structure, in bytes. The caller must set this member to size of (COS_INT_SETUP).</p>
Return Value	<p>TRUE if setup successes</p> <p>FALSE if setup failed</p>
Usage	<pre> COS_INT_SETUP setup; memset(&setup, 0, sizeof(setup)); setup.portMask = 0x0f; // enable ch.0~3 setup.edgeMode = 0; // level setup.edgeType = 0x00; // Lo/Hi BOOL bRet = SetupDICOS(&setup, sizeof(setup)); </pre>

RegisterCallbackDICOS

Syntax	BOOL RegisterCallbackDICOS(COS_INT_CALLBACK callback);
Description:	Registers a callback function, which is called when the DICOS interrupt occurred.
Parameter	<p>callback [in]</p> <p>Specifies the callback function. The prototype for this function is described as follow.</p> <pre>void __stdcall callback_func(COS_INT_CALLBACK_ARG* arg);</pre>
Return Value	<p>TRUE if setup successes,</p> <p>FALSE if setup failed.</p>
Usage	<pre>void __stdcall callback_func(COS_INT_CALLBACK_ARG* arg) { printf("data=0x%02x, flag=0x%02x, seq=%02d\n", arg->portData, arg->intrFlag, arg->intrSeq); } BOOL bRet = RegisterCallbackDICOS(callback_func);</pre>

StartDICOS

Syntax	BOOL StartDICOS(void);
Description	Start DI Change-of-State interrupt
Parameter	None
Return Value	<p>TRUE if start procedure successes</p> <p>FALSE if start procedure failed</p>
Usage	BOOL bRet = StartDICOS();

StopDICOS

Syntax	BOOL StopDICOS(void);
Description	Stop DI Change-of-State interrupt
Parameter	None
Return Value	TRUE if stop procedure successes FALSE if stop procedure failed
Usage	BOOL bRet = StopDICOS();

DI COS Example

```

#include <stdio.h>
#include <stdlib.h>
#include <windows.h>
#include "WDT_DIO.h"

//Step 0, define a Change-of-State Interrupt callback function
void __stdcall callback_function(COS_INT_CALLBACK_ARG* arg)
{
    printf("data=0x%02x, flag=0x%02x, seq=%02d\n",
        arg->portData, arg->intrFlag, arg->intrSeq);
}

int main(int argc, char* argv[])
{
    //Step 1, initialize DIO library by invoking InitDIO()
    if (! InitDIO() )
    {
        printf("InitDIO --> FAILED\n");
        return -1;
    }
    printf("InitDIO --> PASSED\n");

    //Step 2, setup Change-of-State Interrupt mask and level/edge mode
    COS_INT_SETUP setup;
  
```

```
memset(&setup, 0, sizeof(setup));

setup.portMask = 0x0f;      // 00001111b, enable ch.0~3
setup.edgeMode = 0x00;     // generate interrupt on level change
setup.edgeType = 0x00;     // rising/falling edge, only effective when
edgeMode = 1

if ( ! SetupDICOS(&setup, sizeof(setup)) )
{
    printf("SetupDICOS --> FAILED\n");
    return -2;
}
printf("SetupDICOS --> PASSED\n");

//Step 3, register the callback function
if ( ! RegisterCallbackDICOS(callback_function) )
{
    printf("RegisterCallbackDICOS --> FAILED\n");
    return -3;
}
printf("RegisterCallbackDICOS --> PASSED\n");

//Step 4, start the DI Change-of-State Interrupt
if ( ! StartDICOS() )
{
    printf("StartDICOS --> FAILED\n");
    return -4;
}
printf("StartDICOS --> PASSED\n");

printf("\npress any key to stop...\n");
system("pause >nul");

//Step 5, stop the DI Change-of-State Interrupt operation
if ( ! StopDICOS() )
{
    printf("StopDICOS --> FAILED\n");
    return -5;
}
```

```
}  
printf("StopDICOS --> PASSED\n");  
  
printf("\npress any key to exit...\n");  
system("pause >nul");  
return 0;  
}
```