

基準公差表	
L ≤ 10	±0.50
10 < L ≤ 60	±0.80
60 < L ≤ 100	±1.00
100 < L	±1.50
ANGULAR DIMENSION	±2°

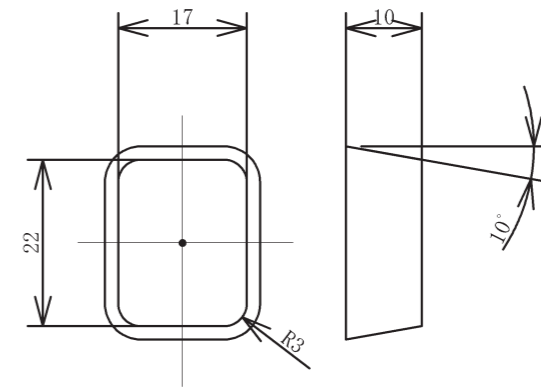

ポケット寸法

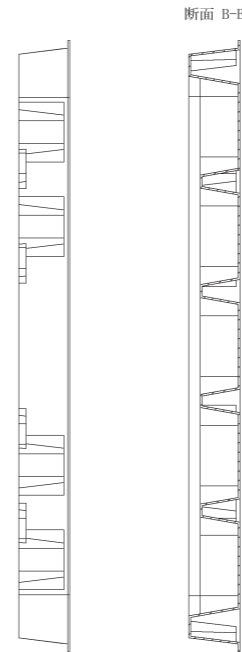
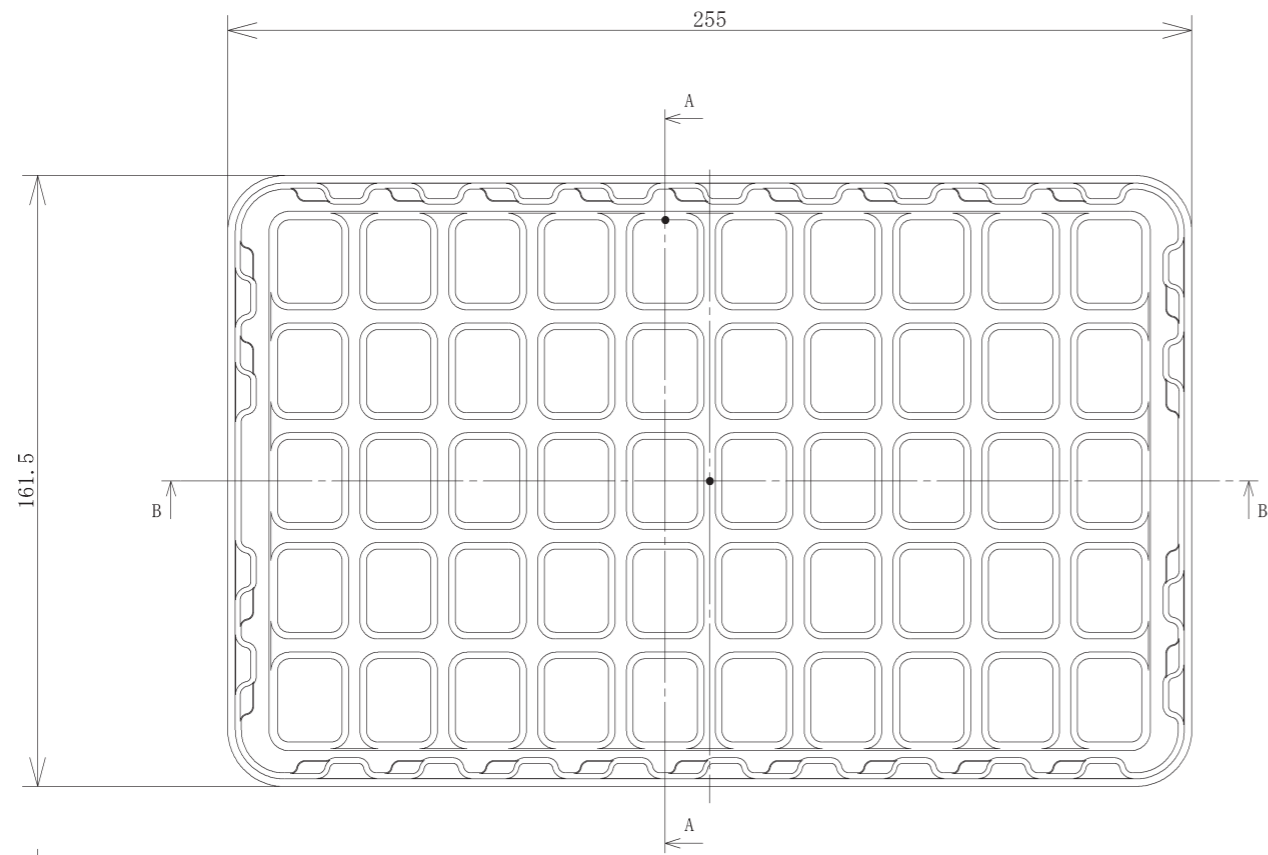
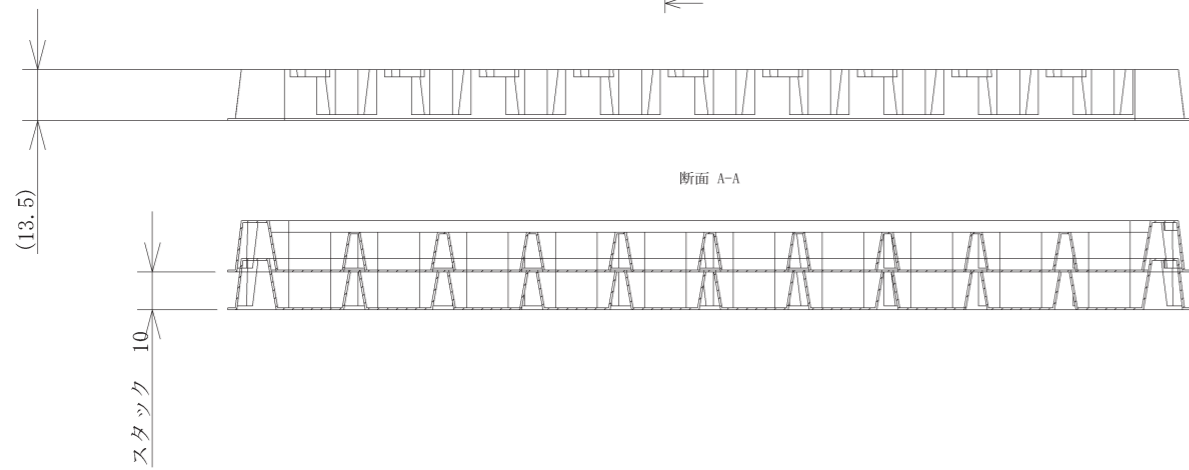

TITLE			e-TRAY (A017022)		
FINISH			255×161.5 17×22 S 10 50P		
DATE		MATERIAL NAME			
2009/02/01		APET t=0.5mm			
SCALE	DESIGN BY	CHECKED BY			
1:2					
	DRAWN BY	APPROVED BY			

部品番号