

## ■ 本体

### MSV/MSV-S

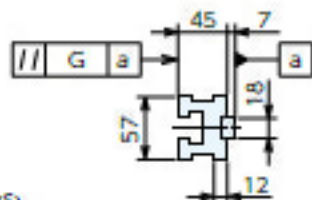

MSV300(S), 310(S), 400(S), 410(S), 510(S),  
400(S)-3, 410(S)-3, 510(S)-3, 510(S)-4

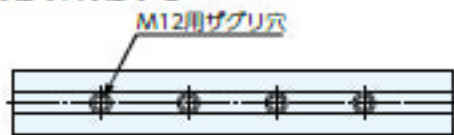
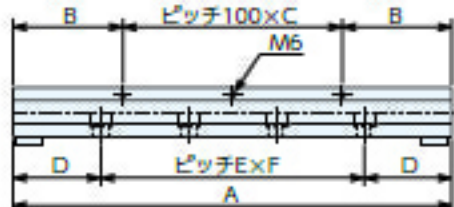

MSV500(S), 500(S)-3, 500(S)-4

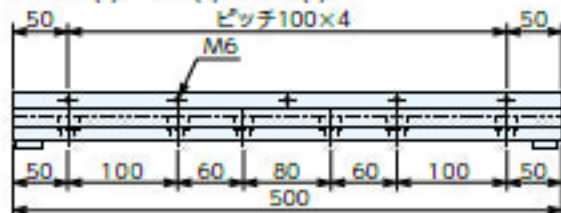

## ■ 可動部

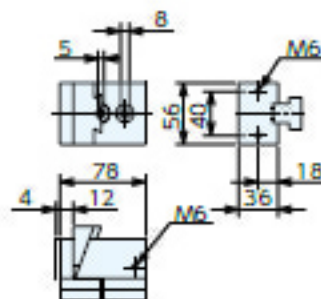

## ■ 固定ブロック

(キー溝仕様以外)

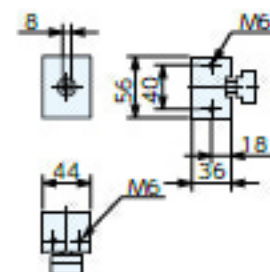

## ■ 本体

### MSV-K

MSV400K, 400K-3

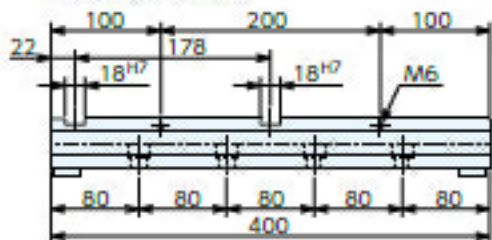

MSV500K, 500K-3, 500K-4

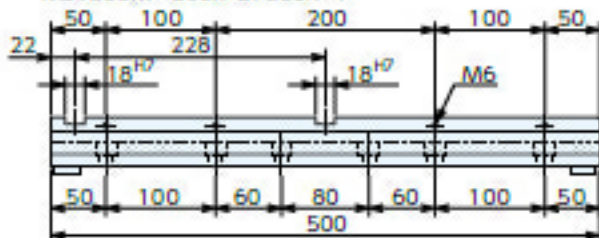

## ■ 固定ブロック

(キー溝仕様)

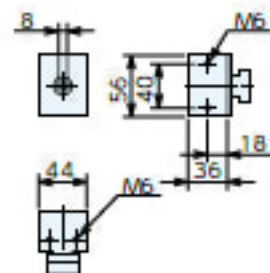

## ■ 口金

### 標準口金

MSV-56JA

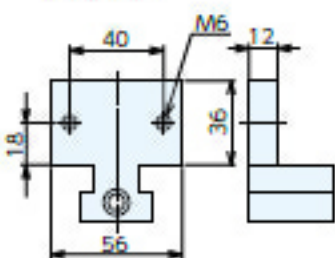

### ローレット口金

MSV-56KJ

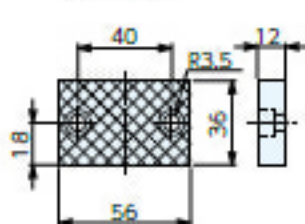

### ソフト口金

MSV-56NJ

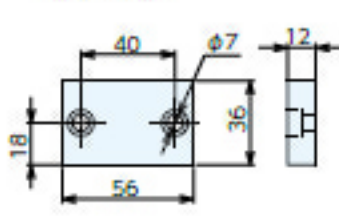

### ユニバーサル口金

MSV-56UJ

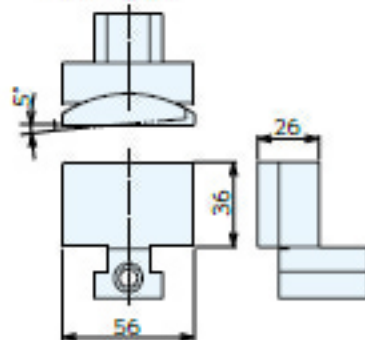

### ステップ口金

MSV-56SJ

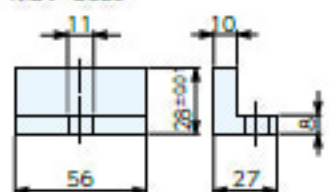

### 円柱用口金

MSV-56CJ

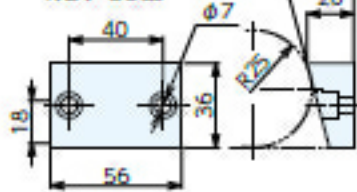

### セルフカット用口金

MSV-56SCJ

