

600 Series Benders

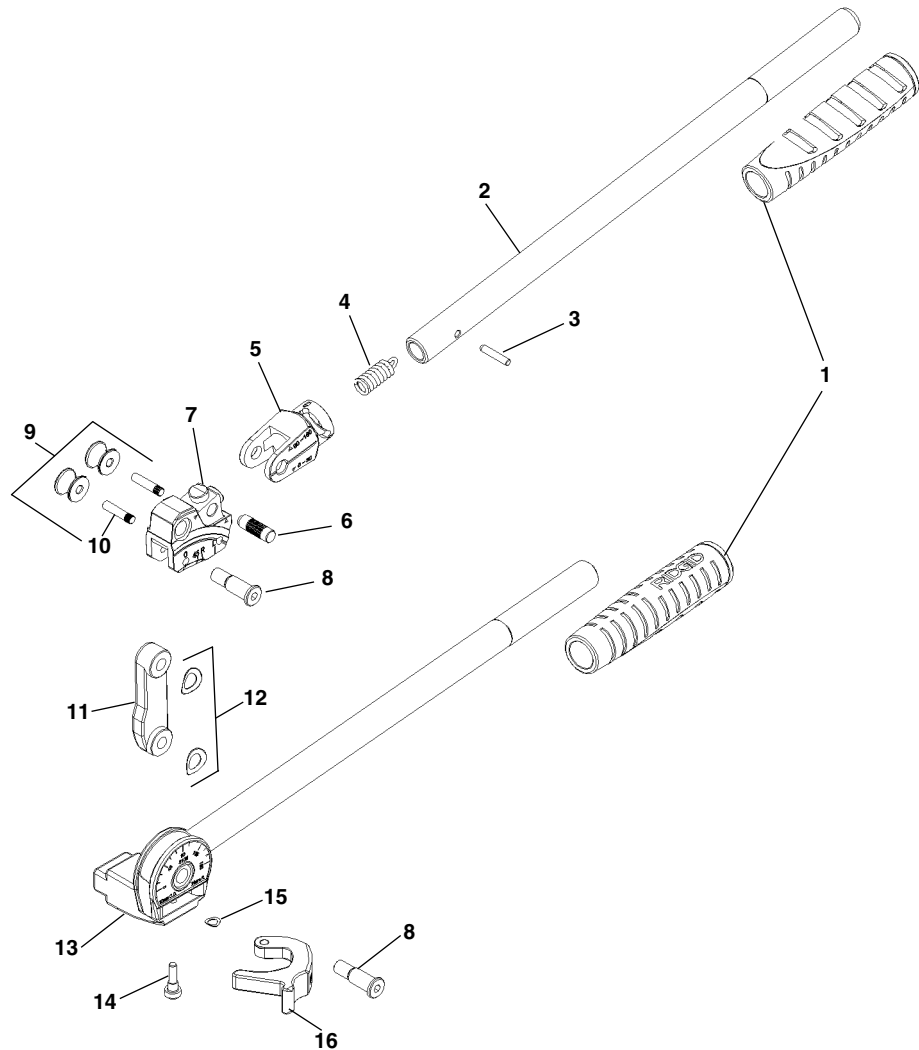

**NOTE: Order parts by Catalog Number only.
DO NOT order by Reference Number.**

Ref No.	Description	603	604	605	606	606M	608	608M	610M	612M
		Catalog No.	Catalog No.	Catalog No.	Catalog No.	Catalog No.	Catalog No.	Catalog No.	Catalog No.	Catalog No.
1	Grip Set	42053	42053	42058	42058	42058	42053	42058	42058	42058
2	Carriage Handle	41933	41933	41938	41938	41943	41933	41938	41938	41943
3	Handle Pin	42108	42108	42113	42113	42113	42108	42113	42113	42113
4	Release Spring	42118	42118	42123	42123	42123	42118	42123	42123	42123
5	Hook	42088	42088	42093	42093	42093	42088	42093	42093	42093
6	Hook Pin	42098	42098	42103	42103	42103	42098	42103	42103	42103
7	Carriage	41878	41878	41883	41883	41888	41878	41883	41883	41888
8	Link Capscrew	42023	42023	42028	42028	42033	42023	42028	42028	42033
9	Roller Set (Inc. pin)	41948	41953	41958	41963	41978	41973	41958	41983	41988
10	Roller Pin	41993	41993	41998	41998	42003	41993	41998	41998	42003
11	Link	41863	41863	41868	41868	41873	41863	41868	41868	41873
12	Link Washers	42063	42063	42068	42068	42073	42063	42068	42068	42073
13	Form Handle	41893	41898	41903	41908	41918	41913	41903	41923	41928
14	Latch Washer	42078	42078	42078	42078	42083	42078	42078	42078	42083
15	Latch Capscrew	42008	42008	42013	42013	42018	42008	42013	42013	42018
16	Latch	42038	42038	42043	42043	42048	42038	42043	42043	42048