

キャスター、アジャスターネジ径M10

3-6624-02

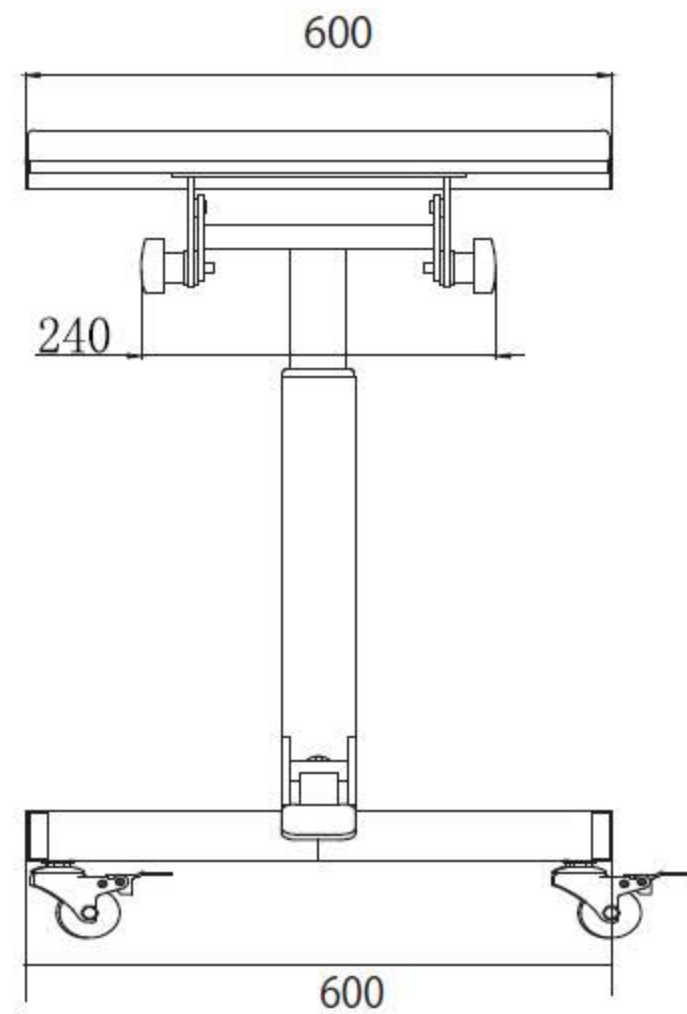

●昇降チルト作業台(650×450)