

13	14	15	16
DATE	NAME	NOTE	
▲			
▲			
▲			

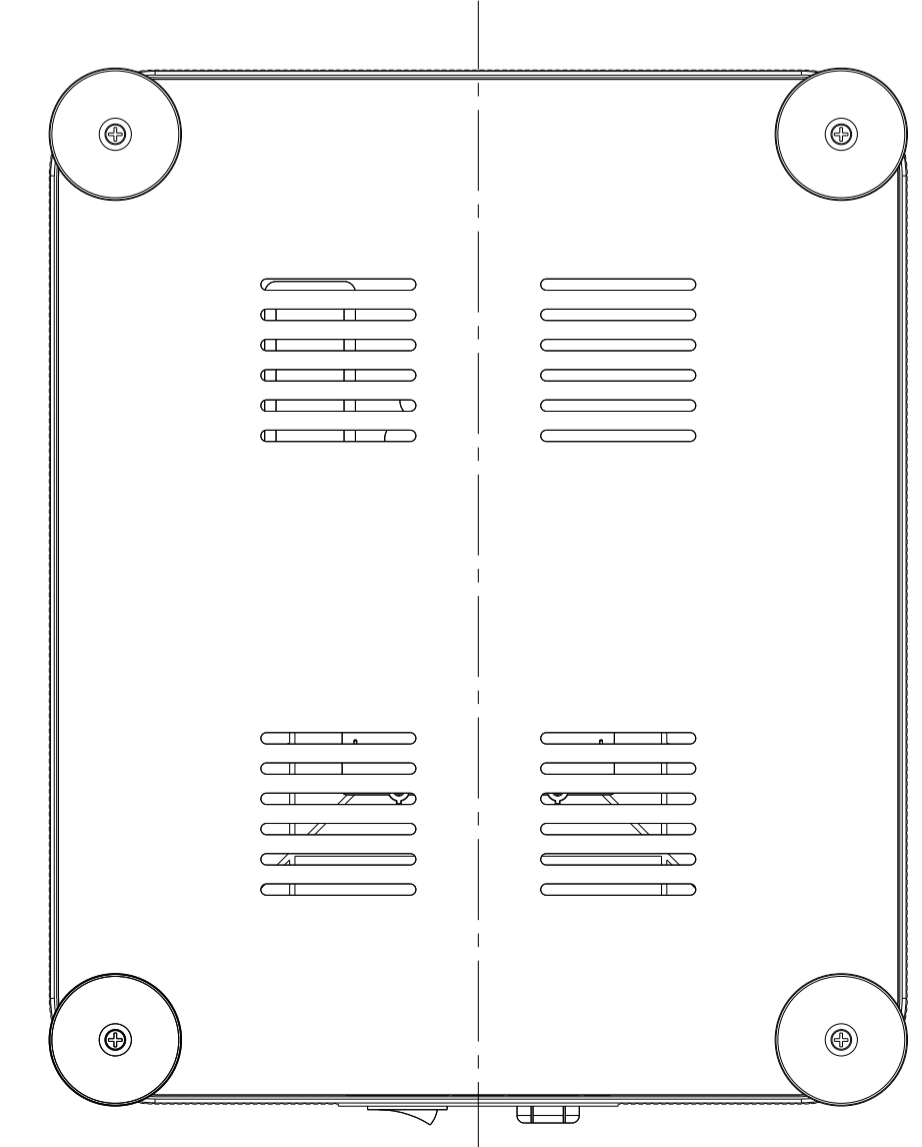
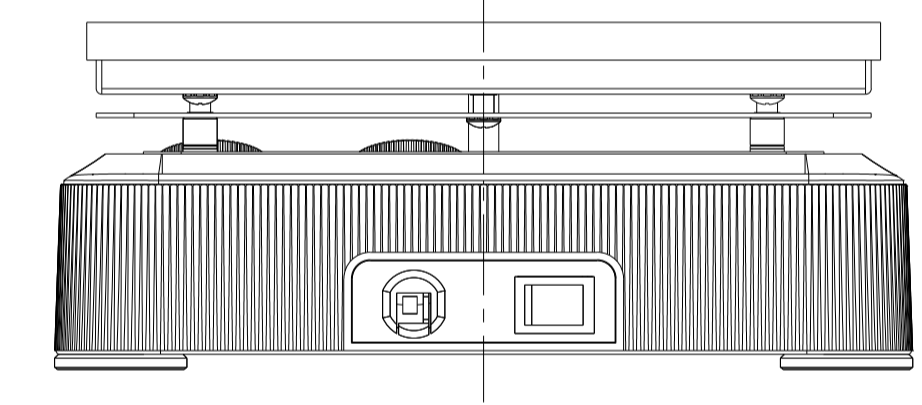
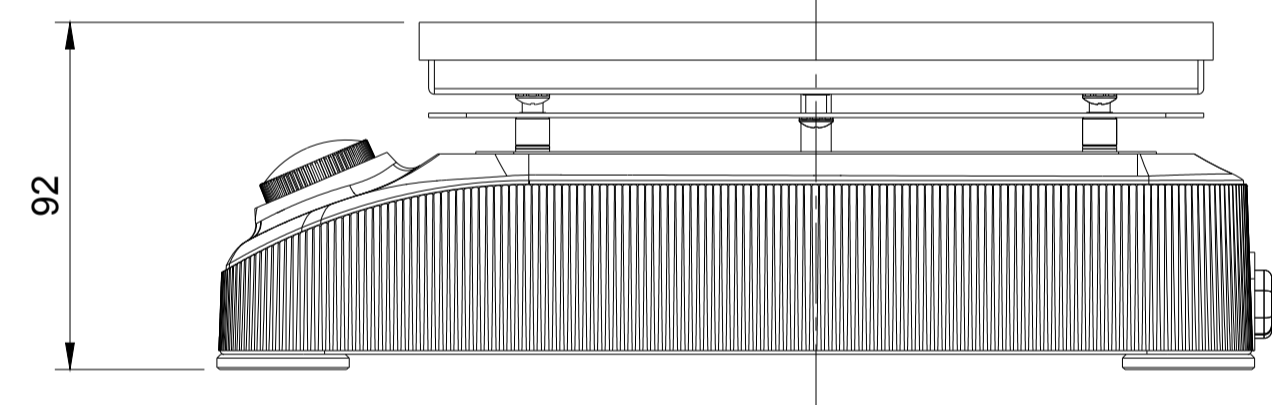
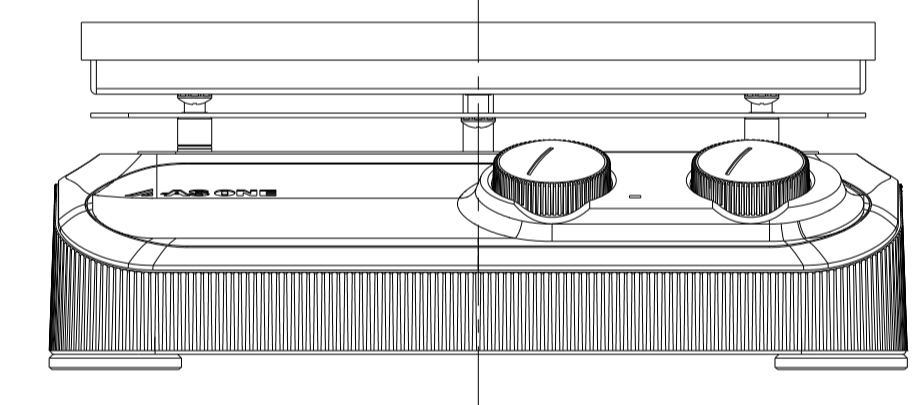
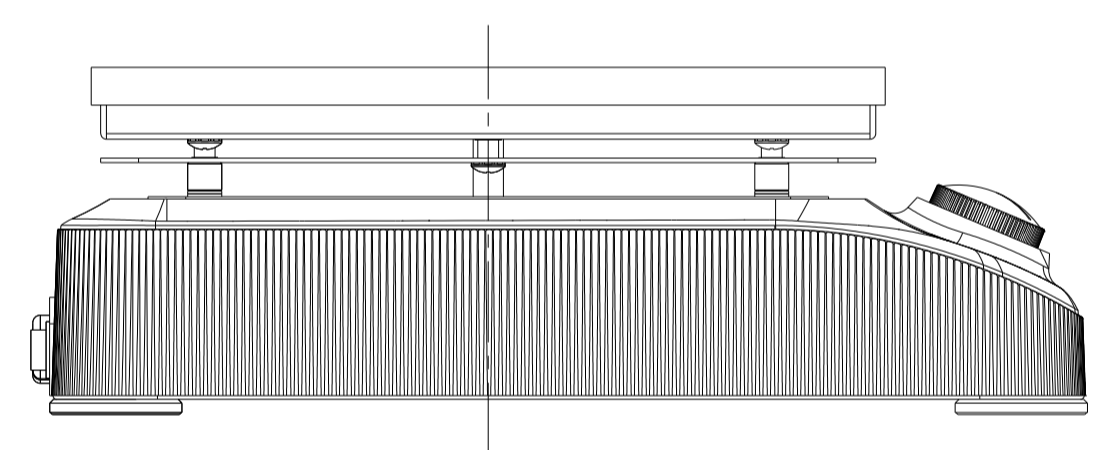
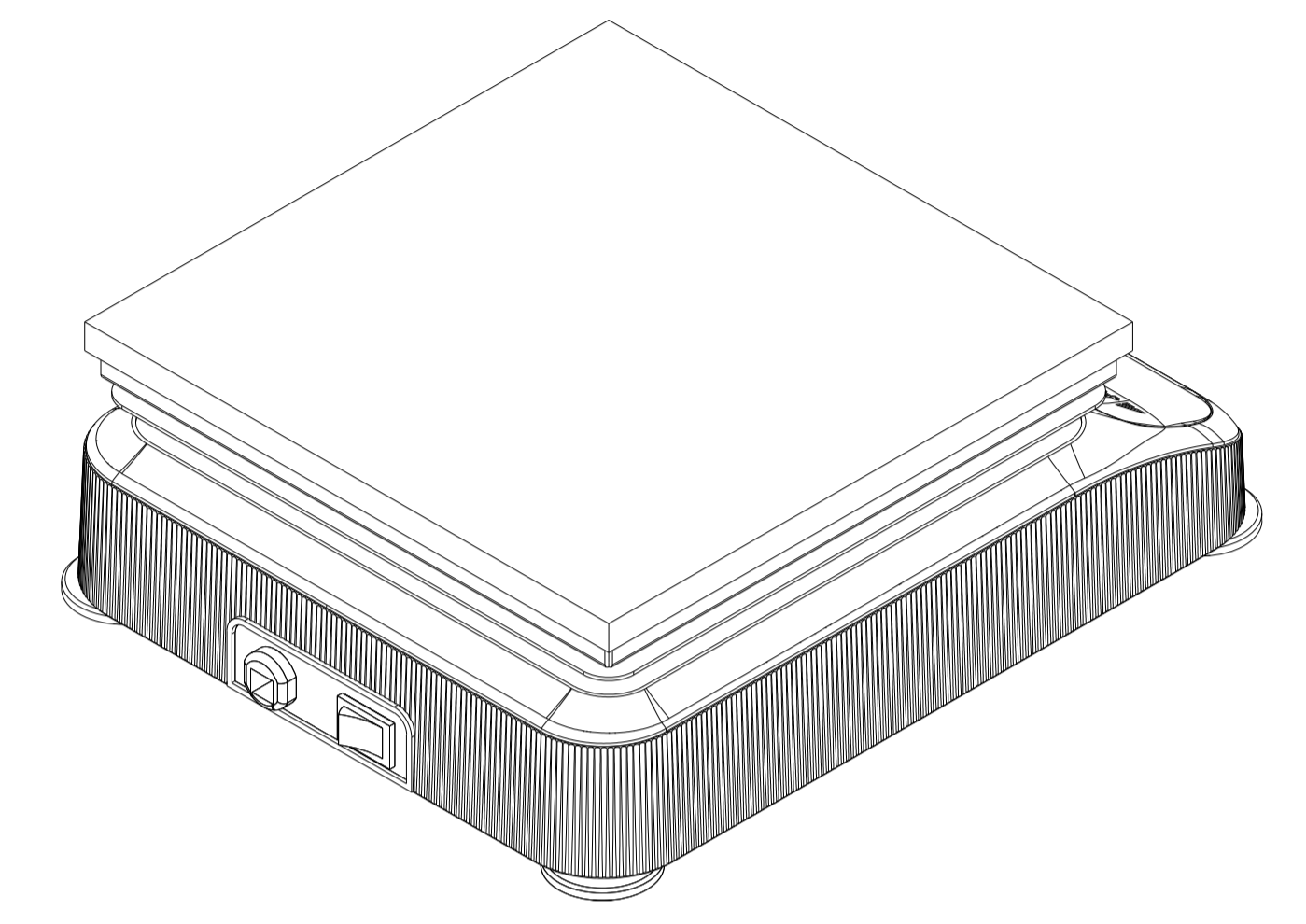
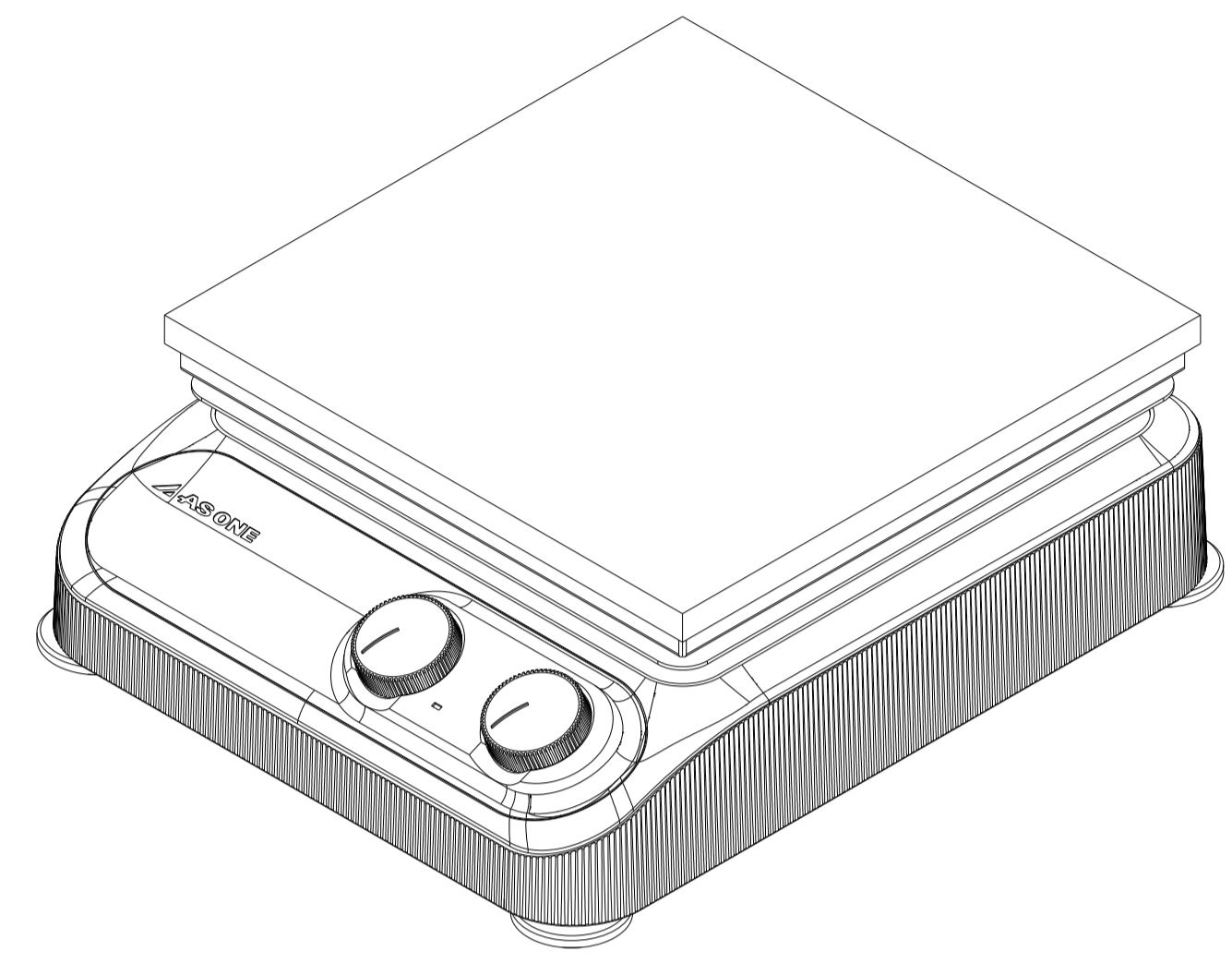
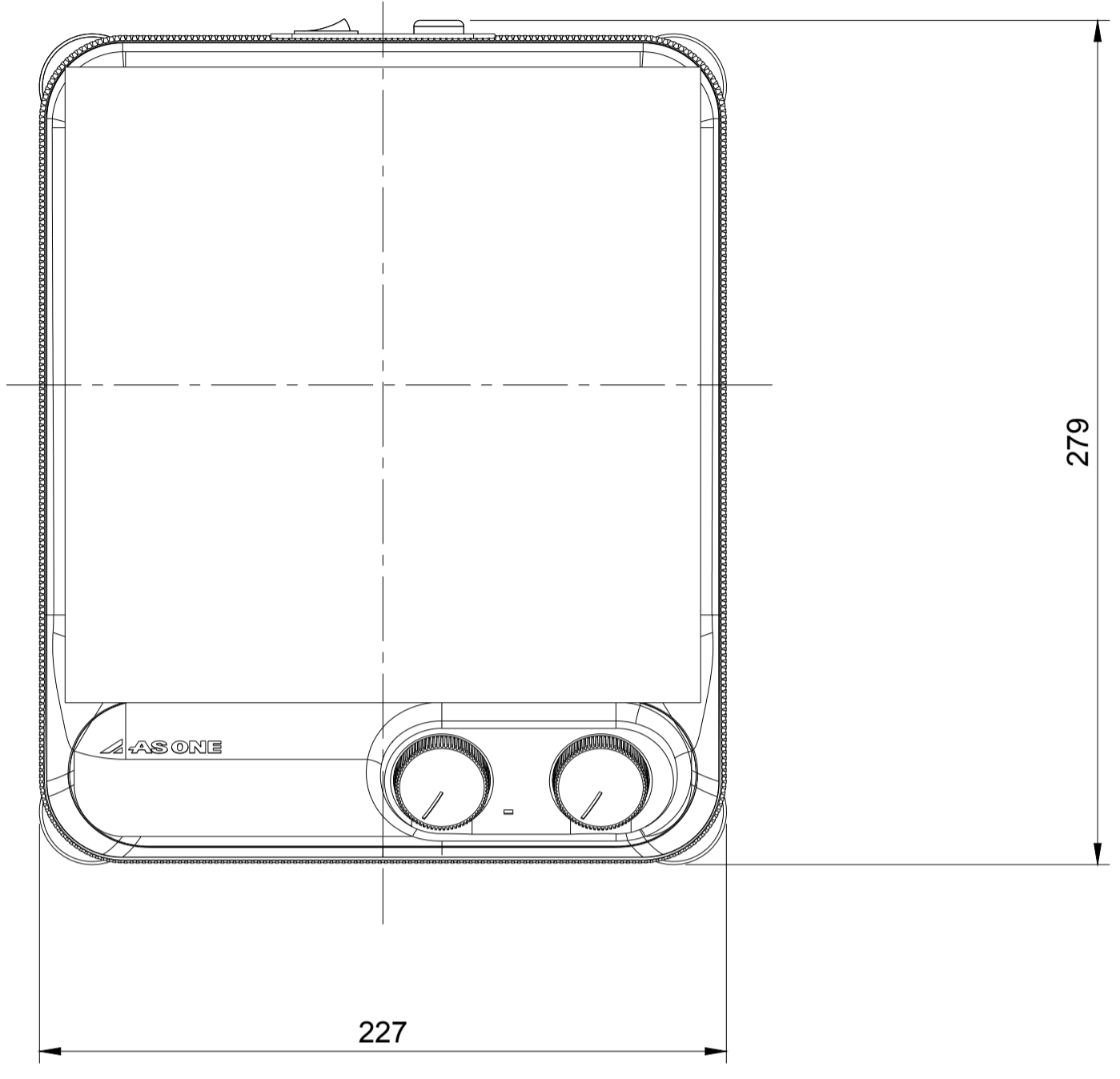

※保証値ではございません。