

Illuminated magnifier MODEL SKKL and MODEL ENVL

Thank you for your purchasing OTSUKA's illuminated magnifier. Check the model name of your magnifier and read the section for it in this instruction manual for long use.

Safety precautions

Before using the device you purchased, be sure to read this "Safety precautions" and understand how to use it. The following section explains important items you must observe to prevent injury to you and other persons or damage to properties and use your device safely. This instruction manual uses various symbols to warn of Max. danger to the user or other persons, as well as property damage. These symbols and their meanings are shown next.

	Ignoring an item under this mark and wrong use could cause death or serious bodily injury.
	Ignoring an item under this mark and wrong use could cause bodily injury or property damage.

	Prohibited items are described under this mark.		Items which you must carry out.		Warnings or cautions.
--	---	--	---------------------------------	--	-----------------------

⊘ ⚠ WARNING

 Since long continuous use of the magnifier tires your eyes and body, take extreme care about working posture and rest. (Stop using the magnifier every 15 minutes and rest your eyes for a while.)	 Do not leave a metal piece such as a clip in the magnifier or splash water or oil over it since they can cause a short circuit or a fire. (Protection class: IP20)	 Do not use or keep the magnifier in a place where there is much dust, moisture, oil mist or steam. Doing so can cause a fire or an electric shock.	 Do not pull the power cable to unplug it. Doing so can cause a short circuit or a fire. Pull it out with the plug part.
 If you look the sun through the lens, the sunbeam will be condensed on your eye and you may lose your sight.	 Do not operate the F-type or CF-type magnifier with your finger in its moving section. If you do so, your finger may be caught, broken or injured.	 If it starts thundering, do not touch a metallic part or power cable of the magnifier. If the thunderbolt strikes the magnifier, you may get an electric shock.	 Do not turn the lens and lamp frame more than 180 degrees. Doing so can cause a disconnection or a short circuit, and that can cause a fire.
 When the F-type, FL-type or CF-type is moved, your hair may wind around its spring. If you have long hair, arrange it with hair clips. <small>Corresponding model: type F CF FL FD</small>	 Bend the arm in the direction of (Λ) usually. Do not bend it in the opposite direction (∨) forcibly. <small>Corresponding model: type F CF FL FD</small>	 Do not hold the electric wire to move or operate the illuminated lens. Doing so can cause a disconnection or a short circuit and that can cause a fire or an electric shock.	 Do not use the magnifier in a place where there may be combustible gas, explosive gas, etc. around it. Doing so can cause a fire or an explosion.
 Be sure to use the AC adapter described on the label. Failure to do so may cause a fatal failure or electric shock.	 If abnormal smell, abnormal sound or smoke comes out, turn off the power immediately and disconnect the power plug. Using the magnifier under this condition can cause a fire.	 Handle the lamp and lens carefully so as not to break them. If they are broken, you may be injured or get an electric shocked. Stop work, and ask it for repair.	 If an FL-type magnifier is set on an inclined place, it may move and collide with another device and may fall down or damage the device consequently. When using the FL-type, set it on a level place and lock its casters. <small>Corresponding model: SKKL - ENVL - FL</small>
 If your hand or elbow is strongly pressed or rubbed against an edge of a pressed or die-cast part, it may be hurt. Take care when handling.	 If dust is accumulated on the power plug, it can lower insulation with moisture and can cause a fire. Periodically wipe off dust from the power cable with a dry cloth.	 Do not bend or twist the power cable forcibly or place a heavy thing on it. Do not leave the cable bound when using. Doing so can cause a short circuit or a disconnection and that can cause a fire or an electric shock.	 If the power cable or power plug is damaged or broken, do not use them. Using them can cause an electric shock or a fire. For repair of the power cable and power plug, ask the shop at which you purchased them.
 Since a lens is used, it condenses light. Continuous radiation of strong light such as sunbeam to a flammable material can cause a fire. Accordingly, do not set the magnifier on a place where it may be irradiated with such light. While the magnifier is not used, keep the lens cover or a sunbeam blocking cloth on it.	 If the body is given many horizontal turns, the power cable is wound onto it and that can cause an accident. Take care that the power cable will not be wound.	 Please do not use it with the lamp cord pushed like the arrow between pipes. When a free arm is greatly moved, the code might be damaged and it be short if such a usage is done. <small>Corresponding model: type F CF FL FD</small>	 Please do not use it wrapping the lamp cord around the pipe. A big tension might join when such a usage is done, the code be damaged, and it be short. <small>Corresponding model: type F CF FL FD</small>
 Do not touch the magnifier or hold the power plug with wet hand. Doing so can cause an electric shock.	 Do not modify or disassemble the magnifier. Doing so can cause a fire or an electric shock. Once the magnifier is modified or disassembled, it may not be repaired even in the guarantee period. We will not be liable for any property accident or personal accident caused by modification.	 Do not remove the spring unnecessarily from an F-type, FL-type or CF-type magnifier. If it is removed wrongly, it may jump out to a person or may break a peripheral device. The spring must be replaced by a person having the maintenance knowledge according to the proper replacement procedure. <small>Corresponding model: type F CF FL FD</small>	

⚠ CAUTION

 Do not splash water over the lens to wash. If water is splashed, it may enter the body and it can cause blur and mold.	 Do not apply your weight or place a heavy thing on the magnifier. Doing so can cause breakage of a magnifier part.	 If the magnifier is set on an inclined place, it may slide down to break or damage itself or injure your foot.	 If the lens frame (shade) is turned upside down, the interchangeable lens may fall and break itself or injure your foot.												
 Do not wipe the lens with detergent containing polishing powder or a dirty cloth. If you do so, lens surface may be scratched or lens coating may be flaked off. If the lens is stained, wipe it with a lens cleaning cloth or a glass cleaning cloth.	 When the magnifier is moved on a desk, the desk surface may be scratched. The clamp of the F-type and CF-type can scratch the desk surface. If it is necessary to protect the desk surface, place a sheet or a plate under the magnifier.	 If the lens is moved long to the right or left, the stand may tip over and damage the object of observation, etc. because of its weight. Accordingly, select the most suitable model for your working method. When using the A-type, be sure to install the counterweight to prevent the stand from tipping over. <small>Corresponding model: type B</small>	 Limit the angle to the value of "θ ₂ " for the ordinary use. When increasing the angle further, install the counterweight sold separately or place a weight on the stand (a).												
 The magnifier has many moving metallic parts which are in contact with each other. While they are rubbed against each other many times, slight amount of metallic powder may fall. Accordingly, the magnifier is not suitable for use in a clean room. Even if a loss is made in your devices, products, etc. Because of the use of the magnifier, we are not liable for that loss. If the object of observation etc. May be damaged by metallic powder, do not use the magnifier or do not move the movable parts about the object or take other measures to prevent foreign matter from falling over the object.	 If the lens unit is inclined largely, the lens frame will fall and may injure you and may be broken. Refer to the maximum inclination angle "θ ₁ " of the lens unit shown in Table 1.	 <table border="1"> <thead> <tr> <th>Magnification of lens</th> <th>θ₁</th> </tr> </thead> <tbody> <tr> <td>2X~6X</td> <td>Max. 70°</td> </tr> <tr> <td>8X~15X</td> <td>Max. 45°</td> </tr> </tbody> </table> Table 1	Magnification of lens	θ ₁	2X~6X	Max. 70°	8X~15X	Max. 45°	 <table border="1"> <thead> <tr> <th>Magnification of lens</th> <th>θ₂</th> </tr> </thead> <tbody> <tr> <td>2X~6X</td> <td>Max. 40°</td> </tr> <tr> <td>8X~15X</td> <td>Max. 20°</td> </tr> </tbody> </table> Table 2	Magnification of lens	θ ₂	2X~6X	Max. 40°	8X~15X	Max. 20°
Magnification of lens	θ ₁														
2X~6X	Max. 70°														
8X~15X	Max. 45°														
Magnification of lens	θ ₂														
2X~6X	Max. 40°														
8X~15X	Max. 20°														

■ Assembling method of main body (base part and arm part)

Model : SKKL-ST, SKKL-D, ENVL-ST, ENVL-D

«Attach a cross bar unit to a lens frame unit with an attached hexagon spanner.»

- ①Screw a crossbar unit into the screw aperture of the lamp frame unit by hand. (Fig.1)
- ②Next, Tighten it with a bundled hexagon spanner (19 mm) like figure 2 surely. (Fig.2)

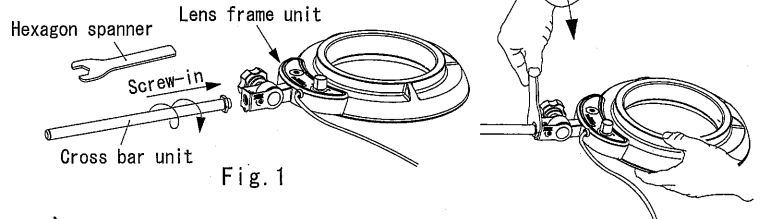

■ Assembly method for body (Stand and arm)

The assembly method depends on the model.
See the list on page 3.

■ Using method

- Plug the included AC power cable into the AC adapter and connect the DC plug to the jack at the end of the input cable that exits the main unit. (Fig.3)
- Connect the power plug to outlet of AC power supply within specification.
- The LED lamp turns on / off by pressing the power switch shown in Fig.4.
- Brightness adjustment 【ENVL series only】

The light intensity can be adjusted with the light control knob shown in Fig.4.
Do not forcibly rotate beyond the adjustment range.

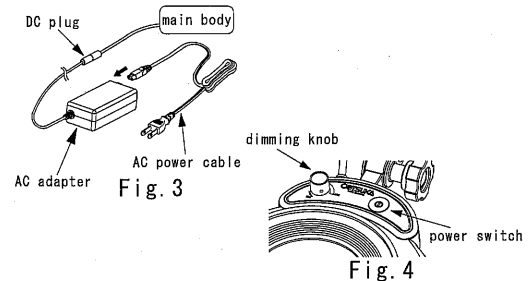

■ Mechanism that swings the lens frame unit horizontally at the position of the bracket part (SKKL-F, SKKL-CF, SKKL-FD, SKKL-FL, ENVL-F, ENVL-CF, ENVL-FD, ENVL-FL)

- ① As for the applicable model, the horizontal swing of the illumination lens frame unit is possible as shown in Fig.5. By using the horizontal swing well, the degree of freedom for setting the illumination lens frame unit as an observation object is expanded.
- ② Adjust to the desired tightening force with the lower grip knob shown in Fig.6.

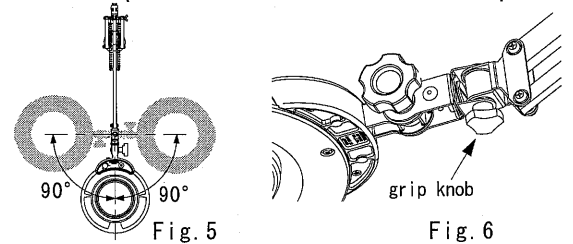

【Note】

If you use it without tightening the grip knob, it may fall unexpectedly onto the object to be observed and damage the object. Pay attention to the looseness of the grip knob.

■ Using and maintenance method of replacement lens

- Magnification varies with the position of the lens between the object and your eyes. Set the lens to a position where you can see the object most clearly and your eyes are least tired. Adjust its height and angle, eye point, and working distance so that it will be parallel with the object as much as possible according to the following table 1.
- When replacing the lens or observing an object, tighten the 8mm knob nut of the Bracket part of the lens frame so securely that the lens frame will not lower. (Fig.5)
- When a lens frame hangs down without enough clamping powers of the 8mm knob nut, adjust the additional fastening screw to show in figure 5 to appropriate clamping by a driver. Because you may damage a brown washer when you close it too much, please be careful.

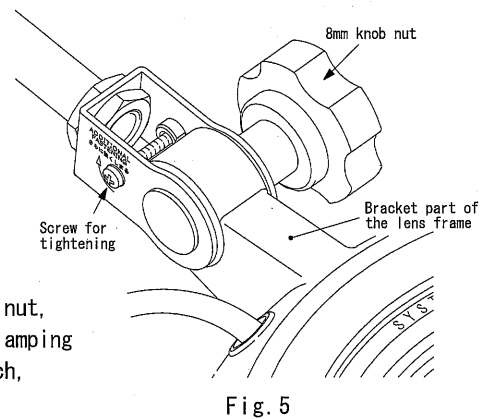

- When using the illuminated magnifier, take measures to prevent the ceiling light from reflecting in the lens and entering your eyes.

●Handling method of replacement lens

- To remove the lens, push its rubber frame rim from below with your fingertips as shown in figure 6.
- If the lens becomes dirty, wipe its surface lightly with the attached wiping cloth or another soft cloth such as gauze, as if you draw circles on it (Fig.7)

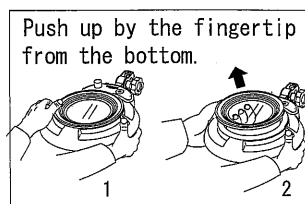

Fig. 6

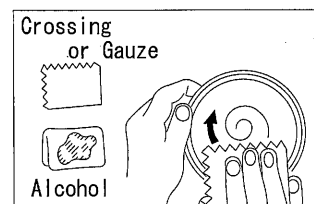

Fig. 7

■ Assembly method for body (stand and arm)

	SKKL-B	ENWL-B	SKKL-F, CF	ENWL-F, CF	SKKL-MS	ENWL-MS	SKKL-ST	ENWL-ST	SKKL-D	ENWL-D	SKKL-FD	ENWL-FD	SKKL-FL	ENWL-FL
■ Outline dimensions														
■ Assembly method for body (Stand and arm)	<ul style="list-style-type: none"> Insert the vertical rod in the stand until it stops and fix it securely with the 4mm set screw of. 	<ul style="list-style-type: none"> Install the clamp stand securely to a table etc. 	<ul style="list-style-type: none"> Clean the surface of the table. Turn the magnet stand ON and fix even if it is steel, in the case of a magnet declines extremely. Please fit to a steel plate, install in a thick board like a surface table. 	<ul style="list-style-type: none"> Install the clamp stand to a table. Insert the vertical rod in the hole until it stops and tighten the 4mm set screw of securely with the L-wrench packed together with the stand. 	<ul style="list-style-type: none"> Fix the flangebase to a workbench etc with 3 screws or 3 bolts and 3 nuts. Fix Flange Bush(b) in the hole of flange base. Insert the shaft, which exited from the bottom of the illumination magnifying glass. Fix it with a screw of 4mm that, by the way, is set in in the place where it stopped. <p>Note)</p> <ul style="list-style-type: none"> It doesn't stabilize if it does not fix. Fix with the screw when you use it. A screw for flange base installation, the bolt is not attached. 	<ul style="list-style-type: none"> Fix the flangebase to a workbench etc with 3 screws or 3 bolts and 3 nuts. Fix Flange Bush(b) in the hole of flange base. Insert the shaft, which exited from the bottom of the illumination magnifying glass. Fix it with a screw of 4mm that, by the way, is set in in the place where it stopped. <p>Note)</p> <ul style="list-style-type: none"> It doesn't stabilize if it does not fix. Fix with the screw when you use it. A screw for flange base installation, the bolt is not attached. 	<ul style="list-style-type: none"> Fix the flangebase to a workbench etc with 3 screws or 3 bolts and 3 nuts. Insert the shaft, which exited from the bottom of the illumination magnifying glass. Fix it with a screw of 4mm that, by the way, is set in in the place where it stopped. <p>Note)</p> <ul style="list-style-type: none"> It doesn't stabilize if it does not fix. Fix with the screw when you use it. A screw for flange base installation, the bolt is not attached. 	<ul style="list-style-type: none"> Joining the shaft from the bottom of the light magnifying glass box firmly with the set screw with the insert knob on the inner part fix it. 						

■ Specifications	SKKL-B	ENWL-B	SKKL-F, CF	ENWL-F, CF	SKKL-MS	ENWL-MS	SKKL-ST	ENWL-ST	SKKL-D	ENWL-D	SKKL-FD	ENWL-FD	SKKL-FL	ENWL-FL
Dimmer	N/A	○	N/A	○	N/A	○	N/A	○	N/A	○	N/A	○	N/A	○
Weight (kg) (excluding the AC adapter, interchangeable lens)	1.9	1.9	F: 2 CF: 1.8	F: 2 CF: 1.8	2.1	2.1	1.2	1.2	1.1	1.1	1.9	1.9	12.1	12.1
Power consumption	7W	10W	7W	10W	7W	10W	7W	10W	7W	10W	7W	10W	7W	10W
Rated frequency	50Hz~60Hz													
Light source	White LED ※1													
Power source	Refer to the main body label. ※2													

AC adapter (Rating, model, weight)	35V/1A, UIA336-3510, 0.3Kg (AC power cable included)													
Lens	interchangeable lens method (2 x ~ 15 x)													
Operating temperature	5°C ~ 35°C													

IP Number	IP20														
Rough dimensions (mm)									AC power cable length: 1800 DC power cable length: 1800	AC power cable length: 1800 DC power cable length: 1800	AC power cable length: 1800 DC power cable length: 1800	AC power cable length: 1800 DC power cable length: 1800	AC power cable length: 1800 DC power cable length: 1800	AC power cable length: 1800 DC power cable length: 1800	AC power cable length: 1800 DC power cable length: 1800
AC adapter (35V/1A) UIA336-3510															
DC power cable length: 1800															

※1 Each LED bulb is manufactured under strict controls. There may be LED bulbs having different colors from the adjacent ones, however. This is not a defect or a trouble. Please understand in advance.
 ※2 The power supply is available to Max 240V by appointing a plug shape.

Replacement lenses (Rough standards)

table 1					
Magnification	①Eye point(mm)	②Lens Aperture(mm)	③Working distance(mm)	④View(mm)	Weight(kg)
2x	150	φ130	160	φ170	0.4
3x	150	φ130	130	φ140	0.5
4x	150	φ130	110	φ120	0.7
6x	100	φ105	82	φ70	0.6
8x	105	φ90	54	φ40	1.3
10x	80	φ90	43	φ40	1.3
12x	80	φ90	35	φ40	1.4
15x	65	φ90	30	φ30	1.4

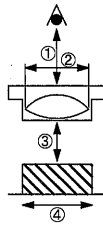

The magnification is a theoretical value calculated than lens curvature. In addition, eye point and working distance are different values by the eyesight of the observer, age. The list showed the average numerical value of the position that looked have few distortions. Look for your position to see most comfortably.

Assembling method of the bracket part

(Each series is common and is assembled at the time of the factory shipment.)
Set a brown washer in both end faces in the bracket part of the lens frame. Insert it between U-shaped metal fittings so that a brown washer does not come off. Insert an 8mm bolt next in a direction of figure 8. Put a metal washer and spacer from the other side, and tighten an 8mm knob nut. (Fig.8)

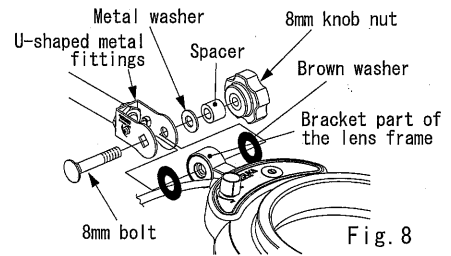

Other precautions

- Do not use thinner, benzene, etc. to clean the body and plastic parts such as the Lamp cover. They can flake the paint and deform the parts.
- Do not use our products in a place where a medical device is used. The former can cause noises in the latter.
- Please do not use this appliance at the place that corrosive gas (you include a sulfur ingredient) produces. When use it in these environment; the change in quality of the lamp, the nature I may cause an ability drop, a change of color, bad insulation.
- This product does not adapt to a standard of ESD(IEC61340-5-1).
- The lens of the illuminated magnifier condenses light. Continuous radiation of strong light such as sunbeam to a flammable material can cause a fire. Accordingly, do not set the magnifier on a place where it may be irradiated with such light. While the magnifier is not used, keep the lens cover, the lens cap (Fig.9) or a sunbeam block-ing cloth on it.

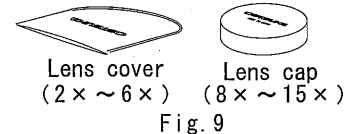

Optional parts (Separate sale)

● Interchangeable lens system (Round series 2x~15x)

I prepare 8 kinds of interchangeable lens. A change of the magnification is possible.

● Multicoated lens (2X~10X)

It is the lens which added anti-reflection coating to all lenses surface. This has high transmissivity and is a bright lens. This prevents that light of the sun and ceiling illumination reflect in a lens.

● φ130 Polarizing Light Filter (for 2X~6X)

● φ90 Polarizing Light Filter (for 8X~15X)

This filter removes the unnecessary surface reflection from an observation thing. This improves observation efficiency.



● Power up lens for 2X

Only putting on the interchangeable lens system 2X, magnification becomes 5X.

Even if you do not take off 2X lens, a magnification change is made quick.

Effective aperture: φ96

Note

This does not support 3X-15X lens.



● L 300 Cross bar

Cross bar of a long type(300mm) You can observe it with more natural posture by changing this part.

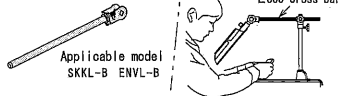

● Counter weight

When you greatly waved a lens part to the left or right, this prevents that the main body falls down by instability. You can observe it without worrying about the fall.

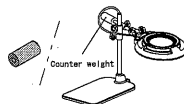

Applicable model
SKKL-B
ENVL-B

● Offset clamp

When a rear wall is near, and a clamp hits something, you can fix the main body at the offset position by changing a normal clamp to a offset clamp.

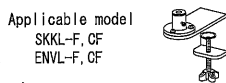

Applicable model
SKKL-F, CF
ENVL-F, CF

● Flange base

When a rear wall is near, and a clamp hits something, you can fix the main body at the offset position by changing a normal clamp to a flange base.

(Note)
This model cannot stand by oneself when not fixed. You must fix it with screws. The screws, bolts for installation are not attached. Please prepare appropriate screws.



Flange base dimension
φ59×35H

Applicable model
SKKL-F, CF
ENVL-F, CF

● Caster stand

It is movable as far as the power supply cord is connected.

Applicable model
SKKL-F, CF
ENVL-F, CF

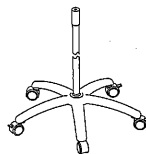

● Cross bar extension

Attaching to the cross bar extension increase the movement range of the lens part can do.

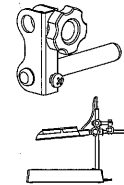

CL type installation example

Applicable model

SKKL-B, CL
ENVL-B, CL

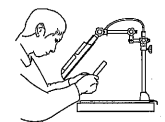

B type installation example

● Conductive base mat for B type

For electrical parts that do not like static electricity using this conductive mat, earth by dropping it to the ground. It can suppress the generation of static electricity. Also prevents scratches on objects due to flexible rubber it can also be used as a mat.



● B type ground wire set

Terminal cable set attached to the back of the conductive base mat for B type to drop it to earth.



● Polarization Light filter holder (for 8X~15X designated)

Polarizing Light filter firmly with rubber capHold, and prevent accident of falling polarizing Light filter beforehand.



After-sales service

- For repair of the illuminated magnifier, ask distributor at which you purchased it.
- This illuminated magnifier has One year guarantee for repairs.

Other items

- We will not guarantee against a damage of the product and its package caused by a forwarding agent's mistake.
- We will not guarantee against a damage of the product caused by a mistake in handling.
- Warranty doesn't cover any loss and expense cost including shipping cost, to arise from use of this products, or breakdown or damage of it.

OTSUKA OPTICS CO., LTD.

Head Office

1-1-4 Koyama Shinagawa-ku Tokyo

〒142-0062 Japan

TEL 03-3491-4126

FAX 03-3491-4120